

- 15P0092B100 -

ASA 4.0 Basic

SOFT STARTER

User Manual

Issued on 01/08/18

R. 01

- This manual is integrant and essential to the product. Carefully read the instructions contained herein as they provide important hints for use and maintenance safety.
- This device is to be used only for the purposes it has been designed to. Other uses should be considered improper and dangerous. The manufacturer is not responsible for possible damages caused by improper, erroneous and irrational uses.
- Elettronica Santerno is responsible for the device in its original setting.
- Any changes to the structure or operating cycle of the device must be performed or authorized by the Engineering Department of Elettronica Santerno.
- Elettronica Santerno assumes no responsibility for the consequences resulting by the use of non-original spare parts.
- Elettronica Santerno reserves the right to make any technical changes to this manual and to the device without prior notice. If printing errors or similar are detected, the corrections will be included in the new releases of the manual.
- The information contained herein is the property of Elettronica Santerno and cannot be reproduced. Elettronica Santerno enforces its rights on the drawings and catalogues according to the law.



Elettronica Santerno S.p.A.
Via della Concia 7, 40023 Castel Guelfo (BO) Italy
Tel. +39 0542 489711 – Fax +39 0542 489722
www.santerno.com, info@santerno.com

Contents

1	About This Manual	4
1.1	Disclaimer	4
2	Caution Statements.....	5
2.1	Electrical shock risk.....	5
2.2	Unexpected Operation	5
2.3	Avertissements à l'attention des clients canadiens	6
3	System Design.....	7
3.1	Feature List	7
3.2	Model Code	7
3.3	Model Selection.....	7
3.4	Current Ratings	8
3.5	Dimensions and Weights	9
3.6	Physical Installation.....	10
3.7	Accessories	10
3.8	Main Contactor	11
3.9	Circuit Breaker.....	11
3.10	Power Factor Correction	11
3.11	Short Circuit Protection Devices (SCPD).....	11
3.12	IEC Coordination with Short Circuit Protection Devices	12
3.13	UL Coordination with Short Circuit Protection Devices	12
3.14	Fuse Selection for Type 2 Coordination.....	14
3.15	Specifications	14
3.16	Disposal Instructions	15
4	Installation on pa.....	16
4.1	Command Source	16
4.2	Setup Procedure Overview	16
4.3	Inputs.....	17
4.4	Outputs.....	18
4.5	Control Voltage.....	19
4.6	Power Terminations	20
4.7	Typical Installation.....	22
4.8	Quick Setup.....	23
5	Setup Tools.....	24
5.1	Command Source	24
5.2	Commissioning.....	24
5.3	Run simulation.....	24
5.4	Load/Save Settings	25
5.5	USB Save & Load	25
5.6	Network Address	26
5.7	Digital I/O State	26
5.8	Analog I/O State	27
5.9	Serial Number & Rating	27
5.10	Software Versions	27
5.11	Thermistor Reset.....	27
5.12	Reset Thermal Model.....	27
6	Logs.....	28
6.1	Event Log	28
6.2	Counters.....	28
6.3	QR Code	28
7	Keypad and Feedback	29
7.1	The Keypad	29
7.2	Remote Keypad.....	29
7.3	Lighten/Darken the Display	29
7.4	Starter status LEDs	30
7.5	Displays.....	30

8	Operation	32
8.1	Start, Stop and Reset Commands	32
8.2	Command Override	32
8.3	Emergency Mode	32
8.4	Auxiliary Trip	32
8.5	Typical Control Methods	33
8.6	Soft Start Methods	34
8.7	Stop Methods	35
9	Programmable Parameters	36
9.1	Main Menu	36
9.2	Altering Parameter Values	36
9.3	Adjustment Lock	36
9.4	Parameter List	36
9.5	1 Motor Details	39
9.6	2 Motor Start/Stop	40
9.7	5 Protection Levels	41
9.8	6 Protection Action	42
9.9	7 Inputs	43
9.10	8 Relay Outputs	45
9.11	9 Analog Output	46
9.12	10 Display	46
9.13	12 Communications Card	48
9.14	20 Advanced	50
9.15	30 Pump Input Configuration	51
9.16	31 Flow Protection	53
9.17	32 Pressure Protection	53
9.18	33 Pressure Control	54
9.19	34 Depth Protection	54
9.20	35 Thermal Protection	55
9.21	36 Pump Trip Action	55
10	Application Examples	57
10.1	Smart Card - Pump Protection	57
10.2	Smart Card - Level Controlled Pump Activation	58
11	Troubleshooting	59
11.1	Protection Responses	59
11.2	Trip Messages	59
11.3	General Faults	62

1 About This Manual



WARNING
Indicates a hazard that may cause personal injury or death.



CAUTION
Indicates a hazard that may damage the equipment or installation.



NOTE
Provides helpful information.

1.1 Disclaimer

The examples and diagrams in this manual are included solely for illustrative purposes.

The information contained in this manual is subject to change at any time and without prior notice. In no event will responsibility or liability be accepted for direct, indirect or consequential damages resulting from the use or application of this equipment.

2 Caution Statements

Caution Statements cannot cover every potential cause of equipment damage but can highlight common causes of damage. It is the installer's responsibility to read and understand all instructions in this manual prior to installing, operating or maintaining the equipment, to follow good electrical practice including applying appropriate personal protective equipment and to seek advice before operating this equipment in a manner other than as described in this manual.



NOTE

The ASA 4.0 Basic is not user serviceable. The unit should only be serviced by authorised service personnel. Unauthorised tampering with the unit will void the product warranty.

2.1 Electrical shock risk



WARNING – ELECTRICAL SHOCK RISK

The voltages present in the following locations can cause severe electric shock and may be lethal:

- AC supply cables and connections
- Output cables and connections
- Many internal parts of the starter



SHORT CIRCUIT

The ASA 4.0 Basic is not short circuit proof. After severe overload or short circuit, the operation of the ASA 4.0 Basic should be fully tested by an authorised service agent.



GROUNDING AND BRANCH CIRCUIT PROTECTION

It is the responsibility of the user or person installing the ASA 4.0 Basic to provide proper grounding and branch circuit protection according to local electrical safety codes.



FOR YOUR SAFETY

- The STOP function of the soft starter does not isolate dangerous voltages from the output of the starter. The soft starter must be disconnected by an approved electrical isolation device before accessing electrical connections.
- Soft starter protection features apply to motor protection only. It is the user's responsibility to ensure safety of personnel operating machinery.
- The soft starter is a component designed for integration within an electrical system; it is therefore the responsibility of the system designer/user to ensure the system is safe and designed to comply with relevant local safety standards.

2.2 Unexpected Operation



WARNING – ACCIDENTAL STARTS

In some installations, accidental starts may pose an increased risk to safety of personnel or damage to the machines being driven. In such cases, it is recommended that the power supply to the soft starter is fitted with an isolating switch and a circuit-breaking device (eg power contactor) controllable through an external safety system (eg emergency stop, fault detector).



WARNING – STARTER MAY START OR STOP UNEXPECTEDLY

The ASA 4.0 Basic will respond to control commands from various sources, and could start or stop unexpectedly. Always disconnect the soft starter from mains voltage before accessing the starter or load.



WARNING – DISCONNECT MAINS BEFORE ACCESSING STARTER OR LOAD

The soft starter has built-in protections which can trip the starter in the event of faults and thus stop the motor. Voltage fluctuations, power cuts and motor jams may also cause the motor to trip.

The motor could restart after the causes of shutdown are rectified, which may be dangerous for personnel. Always disconnect the soft starter from mains voltage before accessing the starter or load.



CAUTION – MECHANICAL DAMAGE FROM UNEXPECTED RESTART

The motor could restart after the causes of shutdown are rectified, which may be dangerous for certain machines or installations. In such cases, it is essential that appropriate arrangements are made against restarting after unscheduled stops of the motor.

2.3 Avertissements à l'attention des clients canadiens



AVERTISSEMENT

L'icône AVERTISSEMENT ci-contre signale les informations concernant des risques pouvant entraîner des blessures graves, voire mortelles. Pour votre sécurité, veuillez consulter les avertissements sur cette page ou demander une copie du présent manuel en français auprès de votre distributeur local.



AVERTISSEMENT – RISQUE DE CHOC ÉLECTRIQUE

Les zones suivantes sont soumises à des tensions pouvant provoquer des risques de chocs électriques graves, voire mortels :

- Raccordement et câbles d'alimentation AC
- Câbles et raccordements de sortie
- De nombreuses pièces internes du démarreur



PAR SÉCURITÉ

- La fonction STOP du démarreur progressif n'isole pas des tensions dangereuses de la sortie du démarreur. Le démarreur progressif doit être déconnecté par un dispositif d'isolement électrique approprié avant d'accéder aux connexions électriques.
- Les fonctions de protection du démarreur progressif ne concernent que la protection du moteur. Il relève de la responsabilité de l'utilisateur d'assurer la sécurité des personnes travaillant sur les machines.
- Le démarreur progressif est un appareil conçu pour s'intégrer dans un système électrique ; il relève donc de la responsabilité du concepteur ou de l'utilisateur de veiller à ce que ce système soit sûr et conçu selon les normes de sécurité locales en vigueur.



AVERTISSEMENT – DÉMARRAGES ACCIDENTELS

Dans certaines installations, des démarrages accidentels peuvent provoquer un risque supplémentaire pour la sécurité des personnes ou endommager les machines contrôlées. Dans de tels cas, il est recommandé de doter l'alimentation du démarreur progressif d'un interrupteur d'isolement et d'un coupe-circuit (par exemple, un disjoncteur) contrôlable à partir d'un système de sécurité externe (par exemple, un arrêt d'urgence, un détecteur de défaut).



AVERTISSEMENT – LE DÉMARREUR PEUT DÉMARRER OU S'ARRÊTER À TOUT MOMENT

Le démarreur progressif répond aux commandes de contrôle de différentes origines et peut par conséquent démarrer ou s'arrêter à tout moment. Toujours déconnecter le démarreur de la tension secteur avant d'accéder au démarreur ou à la charge.



AVERTISSEMENT – DÉCONNECTER L'ALIMENTATION PRINCIPALE AVANT D'ACCÉDER AU DÉMARREUR OU À LA CHARGE

Le démarreur progressif comporte des protections intégrées qui peuvent déclencher des mises en sécurité dans l'éventualité de défauts et ainsi arrêter le moteur. Des fluctuations de tension, des coupures d'alimentation et des blocages du moteur peuvent produire des mises en sécurité de celui-ci.

Le moteur pourrait redémarrer une fois que les causes de l'arrêt ont été résolues, ce qui pourrait mettre en danger le personnel. Toujours déconnecter le démarreur de la tension secteur avant d'accéder au démarreur ou à la charge.



AVERTISSEMENT

Ne pas appliquer la tension du secteur au démarreur tant que tout le câblage n'est pas terminé.



AVERTISSEMENT

Toujours appliquer la tension de commande avant (ou en même temps que) la tension secteur.



AVERTISSEMENT

Si l'entrée de démarrage est fermée lorsque la tension de commande est appliquée, le démarreur tentera d'effectuer un démarrage.

Vérifier que l'entrée de démarrage/arrêt est ouverte avant d'appliquer la tension de commande..

3 System Design

3.1 Feature List

Streamlined setup process

- Configuration profiles for common applications
- Built-in metering and inputs/outputs

Easy to understand interface

- Multi-language menus and displays
- Descriptive option names and feedback messages
- Real-time performance graphs

Supports energy efficiency

- IE3 compatible
- 99% energy efficient when running
- Internal bypass
- Soft start technology avoids harmonic distortion

Extensive range of models

- 24 A~580 A (nominal)
- 200~525 VAC
- 380~600 VAC

Versatile starting and stopping options

- Adaptive Control
- Constant Current
- Current Ramp
- Timed voltage ramp soft stop
- Coast To Stop

Customisable protection

- Motor overload
- Excess Start Time
- Undercurrent
- Overcurrent
- Current imbalance
- Input Trip
- Motor thermistor

Extensive input and output options

- Remote control inputs (2 x fixed, 2 x programmable)
- Relay outputs (1 x fixed, 2 x programmable)
- Analog output

Optional features for advanced applications

- Smart cards
- Communication options: DeviceNet, Ethernet/IP, Modbus RTU, Modbus TCP, Profibus, Profinet

3.2 Model Code

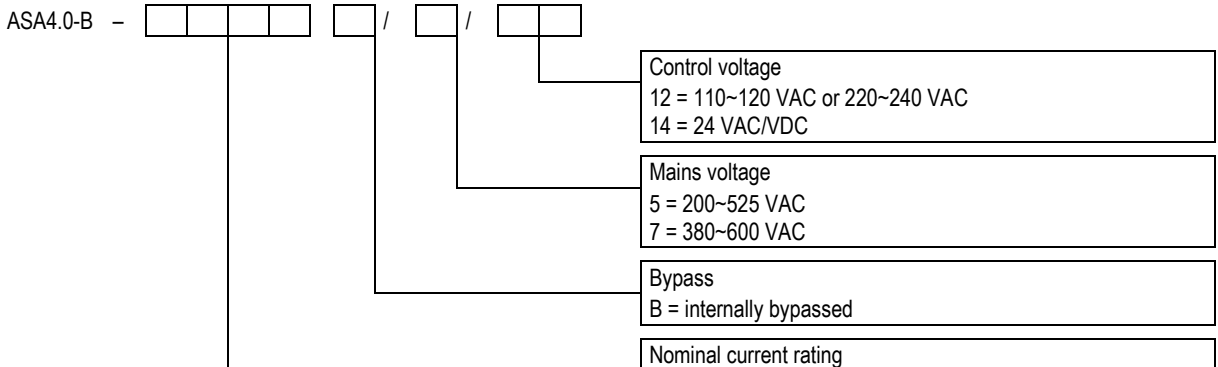

3.3 Model Selection

3.3.1 Starter sizing

The soft starter must be the correct size for the motor and the application.

Select a soft starter that has a current rating at least equal to the motor's full load current (nameplate) rating, at the start duty.

The soft starter's current rating determines the maximum motor size it can be used with. The soft starter's rating depends on the number of starts per hour, the length and current level of the start, and the amount of time the soft starter will be off (not passing current) between starts.

The soft starter's current rating is only valid when used in the conditions specified in the AC53b code - the soft starter may have a higher or lower current rating in different operating conditions.

3.4 Current Ratings

For operating conditions not covered by these ratings charts, download Santerno's free WinStart selection application, or contact your local supplier.

3.4.1 IEC ratings

AC53b format

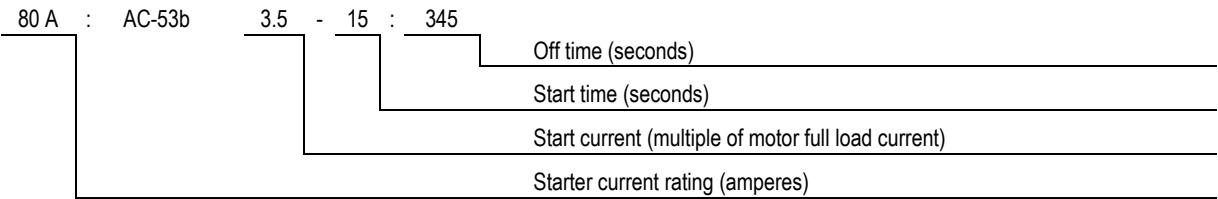

Ratings

All ratings are calculated at altitude of 1000 metres and ambient temperature of 40 °C.

	3.0-10:350	3.5-15:345	4.0-10:350	4.0-20:340	5.0-5:355
ASA4.0-B 0024B	24	20	19	16	17
ASA4.0-B 0042B	42	34	34	27	32
ASA4.0-B 0052B	52	42	39	35	34
	3.0-10:590	3.5-15:585	4.0-10:590	4.0-20:580	5.0-5:595
ASA4.0-B 0064B	64	63	60	51	54
ASA4.0-B 0069B	69	69	69	62	65
ASA4.0-B 0105B	105	86	84	69	77
ASA4.0-B 0115B	115	108	105	86	95
ASA4.0-B 0135B	135	129	126	103	115
ASA4.0-B 0184B	184	144	139	116	127
ASA4.0-B 0200B	200	171	165	138	150
ASA4.0-B 0229B	229	194	187	157	170
ASA4.0-B 0250B	250	244	230	200	202
ASA4.0-B 0352B	352	287	277	234	258
ASA4.0-B 0397B	397	323	311	263	289
ASA4.0-B 0410B	410	410	410	380	400
ASA4.0-B 0550B	550	527	506	427	464
ASA4.0-B 0580B	580	579	555	470	508

3.5 Dimensions and Weights

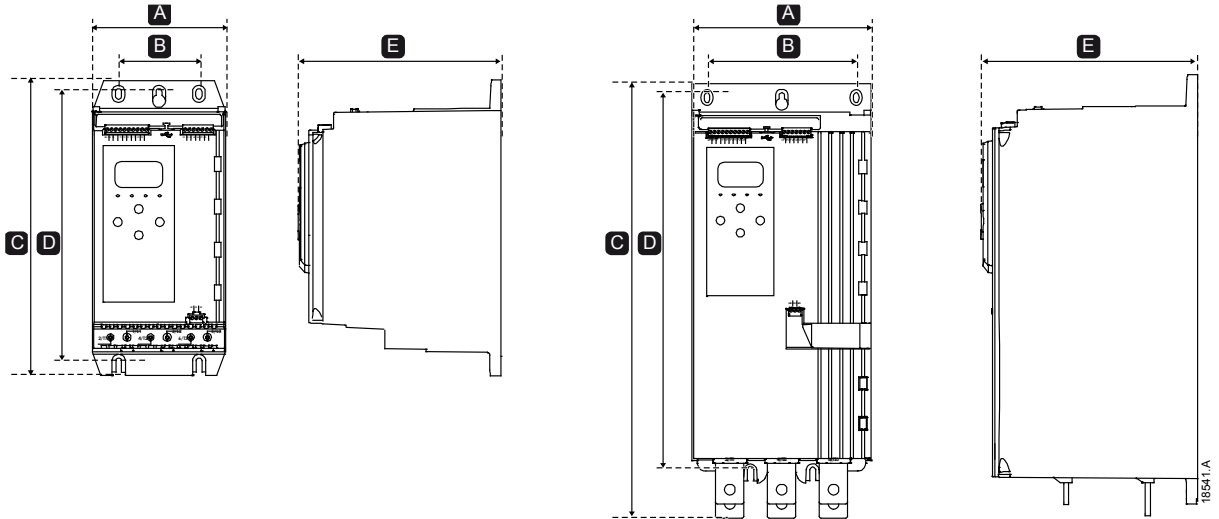

	Width mm (inch)		Height mm (inch)		Depth mm (inch)	Weight kg (lb)	
	A	B	C	D	E		
ASA4.0-B 0024B	152 (6.0)	92 (3.6)	336 (13.2)	307 (12.1)	231 (9.1)	4.7 (10.4)	
ASA4.0-B 0042B						4.8 (10.7)	
ASA4.0-B 0052B						5.0 (11.0)	
ASA4.0-B 0064B							
ASA4.0-B 0069B							
ASA4.0-B 0105B							
ASA4.0-B 0115B							
ASA4.0-B 0135B	216 (8.5)	180 (7.1)	495 (19.5)	450 (17.7)	243 (9.6)	11.7 (25.8)	
ASA4.0-B 0184B						12.5 (27.6)	
ASA4.0-B 0200B						15.0 (33.1)	
ASA4.0-B 0229B							
ASA4.0-B 0250B			523 (20.6)				
ASA4.0-B 0352B							
ASA4.0-B 0397B							
ASA4.0-B 0410B							
ASA4.0-B 0550B							
ASA4.0-B 0580B							

3.6 Physical Installation

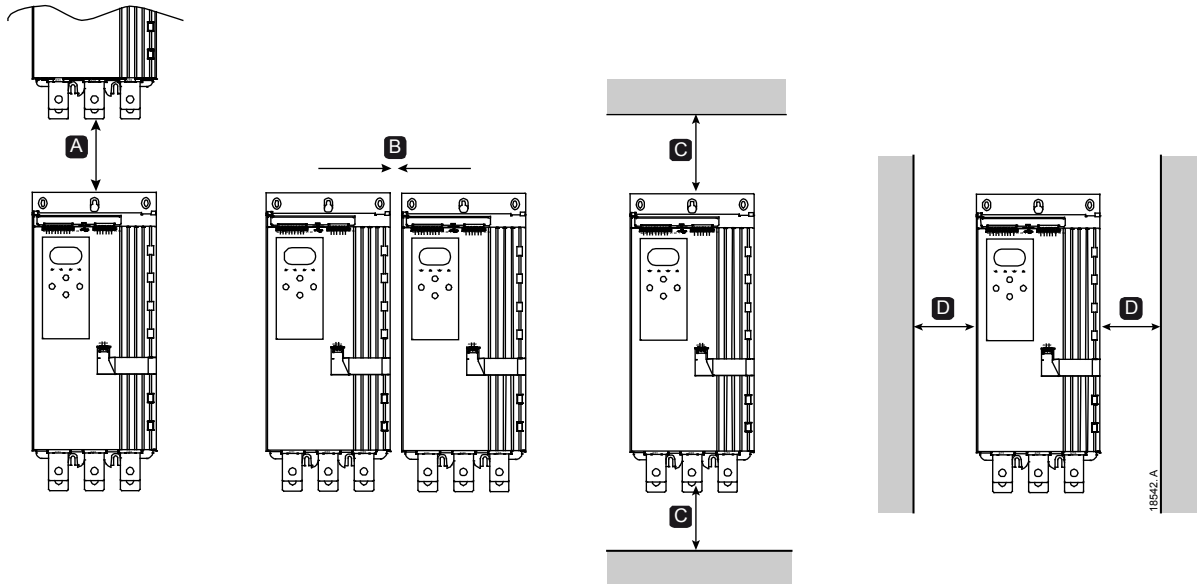

Between starters		Solid surfaces	
A	B	C	D
> 100 mm (3.9 inch)	> 10 mm (0.4 inch)	> 100 mm (3.9 inch)	> 10 mm (0.4 inch)

3.7 Accessories

3.7.1 Expansion Cards

The ASA 4.0 Basic offers expansion cards for users requiring additional inputs and outputs or advanced functionality. Each ASA 4.0 Basic can support a maximum of one expansion card.

Smart Card

The smart card has been designed to support integration with pumping applications and provides the following additional inputs and outputs:

- 3 x digital inputs
- 3 x 4-20 mA transducer inputs
- 1 x RTD input
- 1 x USB-B port
- Remote keypad connector

Communication Expansion Cards

The ASA 4.0 Basic supports network communication via easy-to-install communications expansion cards. Each communications card includes a remote keypad connector port.

Available protocols:

DeviceNet, Ethernet/IP, Modbus RTU, Modbus TCP, Profibus, Profinet.

3.7.2 Remote Keypad

ASA 4.0 Basic starters can be used with a remote keypad, mounted up to 3 metres away from the starter. Each expansion card includes a keypad connection port, or a dedicated keypad connector card is available.

3.7.3 Finger Guard Kit

Finger guards may be specified for personnel safety. Finger guards fit over the soft starter terminals to prevent accidental contact with live terminals. Finger guards provide IP20 protection when used with cable of diameter 22 mm or greater.

Finger guards are compatible with models ASA4.0-B 0184B ~ ASA4.0-B 0580B.

3.7.4 RemoteDrive Management Software

RemoteDrive PC software allows real-time integrated management of ASA 4.0 Basic soft starters as well as all other Santerno products. RemoteDrive can monitor, control and program the starter across the network.

- RemoteDrive must connect to the ASA 4.0 Basic via a Modbus RTU card.
- RemoteDrive supports networks of up to 247 devices.

3.7.5 Soft Starter Management Software

PC software can provide real-time or offline management of soft starters.

- For real-time management in a network of up to 254 starters, the software must connect to the soft starter via a Modbus TCP or Modbus RTU card. The software can monitor, control and program the starter across the network.
- The software can be used to program the starter via the USB port on the pumping smart card.
- For offline management, a configuration file generated in the software can be loaded into the starter via the USB port.

3.8 Main Contactor

A main contactor is recommended to protect the soft starter from voltage disturbances on the network, while stopped. Select a contactor with an AC3 rating greater than or equal to the full load current rating of the connected motor.

Use the main contactor output (33, 34) to control the contactor.

3.9 Circuit Breaker

A shunt trip circuit breaker may be used instead of a main contactor to isolate the motor circuit in the event of a soft starter trip. The shunt trip mechanism must be powered from the supply side of the circuit breaker or from a separate control supply.

3.10 Power Factor Correction

If power factor correction is used, a dedicated contactor should be used to switch in the capacitors.

To use the ASA 4.0 Basic to control power factor correction, connect the PFC contactor to a programmable relay set to Run. When the motor reaches full speed, the relay will close and power factor correction will be switched in. Do not use the soft starter relay output to directly switch in power factor correction.

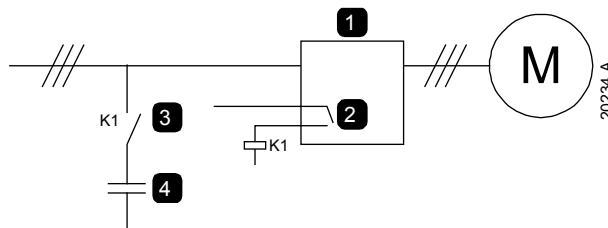

1	Soft starter
2	Programmable output (set = Run)
3	Power factor correction contactor
4	Power factor correction



CAUTION

Power factor correction capacitors must be connected to the input side of the soft starter. Connecting power factor correction capacitors to the output side will damage the soft starter.

3.11 Short Circuit Protection Devices (SCPD)

Fuses may be installed to protect the soft starter or the installation.

3.11.1 Type 1 Coordination

Type 1 coordination requires that, in the event of a short circuit on the output side of a soft starter, the fault must be cleared without risk of injury to personnel. There is no requirement that the soft starter must remain operational after the fault.

HRC fuses (such as Ferraz/Mersen AJT fuses) can be used for Type 1 coordination according to IEC 60947-4-2 standard.

3.11.2 Type 2 Coordination

Type 2 coordination requires that in the event of a short circuit on the output side of a soft starter, the fault must be cleared without risk of injury to personnel or damage to the soft starter.

Semiconductor fuses for Type 2 circuit protection are additional to HRC fuses or MCCBs that form part of the motor branch circuit protection.



CAUTION

Integral solid state short circuit protection does not provide branch circuit protection. Branch circuit protection must be provided in accordance with the National Electrical Code and any additional local codes.

3.12 IEC Coordination with Short Circuit Protection Devices

These fuses were selected based on start current of 300% FLC for 10 seconds.

	Nominal Rating (A)	SCR I ² t (A ² s)	Type 1 coordination 480 VAC, 65 kA Bussmann NH fuse links	Type 2 coordination 600 VAC, 65 kA Bussmann DIN 43 653
ASA4.0-B 0024B	24	1150	40NHG000B	170M3010
ASA4.0-B 0042B	42	7200	63NHG000B	170M3013
ASA4.0-B 0052B	52		80NHG000B	
ASA4.0-B 0064B	64	15000	100NHG000B	170M3014
ASA4.0-B 0069B	69			
ASA4.0-B 0105B	105	80000	160NHG00B	170M3015
ASA4.0-B 0115B	115			170M3016
ASA4.0-B 0135B	135	125000	250NHG2B	170M3020
ASA4.0-B 0184B	184	320000		
ASA4.0-B 0200B	200		315NHG2B	
ASA4.0-B 0229B	229			170M3021
ASA4.0-B 0250B	250			
ASA4.0-B 0352B	352	202000	355NHG2B	170M6009
ASA4.0-B 0397B	397		400NHG2B	
ASA4.0-B 0410B	410	320000	425NHG2B	170M6010
ASA4.0-B 0550B	550	781000	630NHG3B	170M6012
ASA4.0-B 0580B	580			

3.13 UL Coordination with Short Circuit Protection Devices

3.13.1 Standard Fault Short Circuit Current Ratings

Suitable for use on a circuit capable of delivering not more than the stated level of amperes (symmetrical rms, refer #1 in table), 600 VAC maximum.

Maximum fuse rating (A) – Standard fault short circuit current

Model	Nominal Rating (A)	3 cycle short cct rating @600 VAC #1 †
ASA4.0-B 0024B	24	5 kA
ASA4.0-B 0042B	42	
ASA4.0-B 0052B	52	10 kA
ASA4.0-B 0064B	64	
ASA4.0-B 0069B	69	
ASA4.0-B 0105B	105	
ASA4.0-B 0115B	120	
ASA4.0-B 0135B	135	
ASA4.0-B 0184B	184	18 kA
ASA4.0-B 0200B	225	
ASA4.0-B 0229B	229	
ASA4.0-B 0250B	250	
ASA4.0-B 0352B	352	
ASA4.0-B 0397B	397	
ASA4.0-B 0410B	410	30 kA
ASA4.0-B 0550B	550	
ASA4.0-B 0580B	580	

† Suitable for use in a circuit with the prospective current noted, when protected by any Listed fuses or Listed circuit breakers sized according to the NEC.

3.13.2 High Fault Short Circuit Current Ratings

Maximum fuse rating (A) – High fault short circuit current

Suitable for use on a circuit capable of delivering not more than 65,000 rms symmetrical amperes, 480 VAC maximum, when protected by fuses of the stated class and rating (refer ##2 and ##3 in table).

Model	Nominal Rating (A)	Short Circuit Rating @ 480 VAC max.	Listed fuse rating (A) ##3	Fuse class ##2
ASA4.0-B 0024B	24	65 kA	30	Any (J, T, K-1, RK1, RK5)
ASA4.0-B 0042B	42		50	
ASA4.0-B 0052B	52		60	
ASA4.0-B 0064B	64		80	
ASA4.0-B 0069B	69		80	
ASA4.0-B 0105B	105		125	J, T, K-1, RK1
ASA4.0-B 0115B	120		125	
ASA4.0-B 0135B	135		150	
ASA4.0-B 0184B	184		200	J, T
ASA4.0-B 0200B	225		225	
ASA4.0-B 0229B	229		250	
ASA4.0-B 0250B	250		300	
ASA4.0-B 0352B	352		400	Any (J, T, K-1, RK1, RK5)
ASA4.0-B 0397B	397		450	
ASA4.0-B 0410B	410		450	
ASA4.0-B 0550B	550		600	
ASA4.0-B 0580B	580		600	

Circuit breakers – High fault short circuit current

Suitable for use on a circuit capable of delivering not more than 65,000 rms symmetrical amperes, 480 VAC maximum, when protected by circuit breaker models noted in ##4, ##5 or ##6.

Model	Nominal Rating (A)	Breaker 1: Eaton (rating, A) ##4	Breaker 2: GE (rating, A) ##5	Breaker 3: LS (rating, A) ¹ ##6
ASA4.0-B 0024B	24	HFD3030 (30 A)	SELA36AT0060 (60 A)	UTS150H-xxU-040 (40 A)
ASA4.0-B 0042B	42	HFD3050 (50 A)		UTS150H-xxU-050 (50 A)
ASA4.0-B 0052B	52	HFD3060 (60 A)		UTS150H-xxU-060 (60 A)
ASA4.0-B 0064B	64	HFD3100 (100 A)	SELA36AT0150 (150 A)	UTS150H-xxU-100 (100 A)
ASA4.0-B 0069B	69			
ASA4.0-B 0105B	105	HFD3125 (125 A)		UTS150H-xxU-125 (125 A)
ASA4.0-B 0115B	120	HFD3150 (150 A)		UTS150H-xxU-150 (150 A)
ASA4.0-B 0135B	135			
ASA4.0-B 0184B	184	HFD3250 (250 A)	SELA36AT0250 (250 A)	UTS150H-xxU-250 (250 A)
ASA4.0-B 0200B	225			
ASA4.0-B 0229B	229			
ASA4.0-B 0250B	250	HFD3300 (300 A)	SELA36AT0400 (400 A)	UTS150H-xxU-300 (300 A)
ASA4.0-B 0352B	352	HFD3400 (400 A)	SELA36AT0600 (600 A)	UTS150H-xxU-400 (400 A)
ASA4.0-B 0397B	397			
ASA4.0-B 0410B	410	HFD3600 (600 A)		UTS150H-xxU-600 (600 A)
ASA4.0-B 0550B	550			UTS150H-xxU-800 (800 A)
ASA4.0-B 0580B	580		UTS150H-NG0-800	

¹ For LS breakers, xx represents FM, FT or AT.

3.14 Fuse Selection for Type 2 Coordination

Type 2 coordination is achieved by using semiconductor fuses. These fuses must be able to carry motor start current and have a total clearing I^2t less than the I^2t of the soft starter SCRs.

When selecting semiconductor fuses for ASA 4.0 Basic, use the I^2t values in the table.

For further information on selecting semiconductor fuses, contact your local distributor.

Model	SCR I^2t (A ² s)
ASA4.0-B 0024B	1150
ASA4.0-B 0042B	7200
ASA4.0-B 0052B	
ASA4.0-B 0064B	15000
ASA4.0-B 0069B	
ASA4.0-B 0105B	80000
ASA4.0-B 0115B	
ASA4.0-B 0135B	125000
ASA4.0-B 0184B	
ASA4.0-B 0200B	320000
ASA4.0-B 0229B	
ASA4.0-B 0250B	
ASA4.0-B 0352B	
ASA4.0-B 0397B	202000
ASA4.0-B 0410B	
ASA4.0-B 0550B	320000
ASA4.0-B 0580B	
	781000

3.15 Specifications

Supply

Mains voltage (L1, L2, L3)

ASA4.0-B xxxxB/5/xx	200~525 VAC (± 10%)
ASA4.0-B xxxxB/7/xx	380~600 VAC (± 10%)

Control voltage (A1, A2, A3)

ASA4.0-B xxxxB/x/12 (A1, A2)	110~120 VAC (+10%/-15%), 600 mA
ASA4.0-B xxxxB/x/12 (A2, A3)	220~240 VAC (+10%/-15%), 600 mA
ASA4.0-B xxxxB/x/14 (A1, A2)	24 VAC/VDC (± 20%), 2.8 A

Mains frequency 50 Hz~60 Hz (±5 Hz)

Rated insulation voltage to earth 600 VAC

Rated impulse withstand voltage 6 kV

Form designation Bypassed or continuous, semiconductor motor starter form 1

Short circuit capability

Coordination with semiconductor fuses Type 2

Coordination with HRC fuses Type 1

Electromagnetic capability (compliant with EU Directive 2014/35/EU)

EMC Immunity IEC 60947-4-2

EMC Emissions IEC 60947-4-2 Class B

Inputs

Input rating Active 24 VDC, 8 mA approx

Motor thermistor (B4, B5) Trip >3.6 kΩ, reset <1.6 kΩ

Outputs

Relay outputs 10 A @ 250 VAC resistive, 5A @ 250 VAC AC15 pf 0.3

Main contactor (33, 34) Normally Open

Relay output A (41, 42, 44) Changeover

Relay output B (53, 54) Normally Open

Analog output (21, 22)

Maximum load 600 Ω (12 VDC @ 20 mA)

Accuracy ± 5%

Environmental

Operating temperature -10 °C~60 °C, above 40 °C with derating

Storage temperature -25 °C~+ 60 °C

Operating Altitude 0~1000 m, above 1000 m with derating

Humidity 5%~95% Relative Humidity

Pollution degree Pollution Degree 3

Vibration	IEC 60068-2-6
Protection	
ASA4.0-B 0024B~ASA4.0-B 0135B	IP20
ASA4.0-B 0184B~ASA4.0-B 0580B	IP00
Heat dissipation	
During Start	4.5 watts per ampere
During Run	
ASA4.0-B 0024B~ASA4.0-B 0052B	≤ 35 watts approx
ASA4.0-B 0064B~ASA4.0-B 0135B	≤ 50 watts approx
ASA4.0-B 0184B~ASA4.0-B 0250B	≤ 120 watts approx
ASA4.0-B 0352B~ASA4.0-B 0580B	≤ 140 watts approx
Motor Overload Protection	
Default: The default settings of parameters 1C, 1D and 1E provide Motor Overload Protection: Class 10, Trip Current 105% of FLA (full load amperage) or equivalent.	
Operational life (internal bypass contacts)	
.....	100 000 operations
Certification	
CE	EN 60947-4-2
EAC (formerly GOST)	TR TC 004/2011 and TR TC 020/2011
C-UL	C22.2 N° 60947-4-2
UL	UL 60947-4-2

3.16 Disposal Instructions

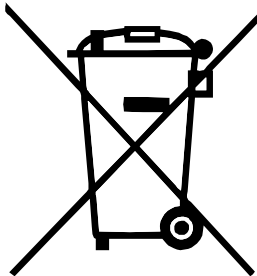

Equipment containing electrical components may not be disposed of together with domestic waste. It must be collected separately as electrical and electronic waste according to local and currently valid legislation.

4 Installation



WARNING

Do not apply mains voltage to the starter until all wiring is complete.



WARNING

Always apply control voltage before (or with) mains voltage.

4.1 Command Source

The ASA 4.0 Basic can be started and stopped via the digital inputs, remote keypad, communication network or smart card. The command source can be set via the Setup Tools, or using parameter 1A *Command Source*.

4.2 Setup Procedure Overview

1. Mount the soft starter (refer to *Physical Installation* on page 10 for details).
2. Connect control wiring (refer to *Input Terminals* on page 17 for details).
3. Apply control voltage to the starter.
4. Configure your application:
 1. Press **MENU** to open the Menu.
 2. Press **▶** to open the Quick Setup menu.
 3. Scroll through the list to find your application, then press **▶** to begin the configuration process (refer to *Quick Setup* on page 22 for details).
5. If your application is not listed in Quick Setup:
 1. Press **◀** to return to the Menu.
 2. Use **▼** to scroll to Main Menu and press **▶**.
 3. Scroll to Motor Details and press **▶**, then press **▶** again to edit parameter 1B *Motor Full Load Current*.
 4. Set parameter 1B to match the motor's full load current (FLC).
 5. Press **▶** to save the setting.
6. Close the Menu by pressing **◀** repeatedly.
7. (Optional) Use the built-in simulation tools to check that the control wiring is connected correctly (refer to *Run simulation* on page 24).
8. Power off the soft starter.
9. Connect the motor cables to starter output terminals 2/T1, 4/T2, 6/T3.
10. Connect mains supply cables to starter input terminals 1/L1, 3/L2, 5/L3 (refer to *Power Input and Output Configurations* on page 20).

The soft starter is now ready to control the motor.

4.3 Inputs



CAUTION

The control inputs are powered by the soft starter. Do not apply external voltage to the control input terminals.



NOTE

Cables to the control inputs must be segregated from mains voltage and motor cabling.

4.3.1 Input Terminals

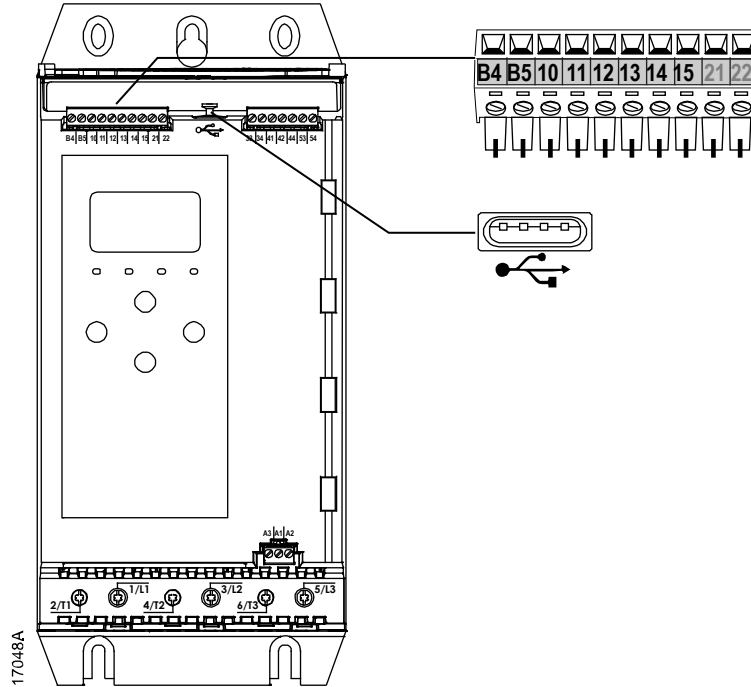

B4, B5	Motor thermistor input
10, 11	Reset input
11, 12	Start/stop input
13, 14	Programmable input A (default = Input Trip (N/O))
13, 15	Programmable input B (default = Input Trip (N/O))
	USB port

4.3.2 Motor Thermistor

Motor thermistors can be connected directly to the ASA 4.0 Basic. The soft starter will trip when the resistance of the thermistor circuit exceeds approximately 3.6 k Ω or falls below 20 Ω .

The thermistors must be wired in series. The thermistor circuit should be run in screened cable and must be electrically isolated from earth and all other power and control circuits.



NOTE

The thermistor input is disabled by default, but activates automatically when a thermistor is detected. If thermistors have previously been connected to the ASA 4.0 Basic but are no longer required, use the Thermistor Reset function to disable the thermistor. Thermistor Reset is accessed via the Setup Tools.

4.3.3 Start/Stop

The ASA 4.0 Basic requires two-wire control.

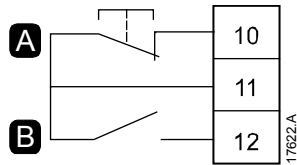

A	Reset
B	Start/Stop



WARNING

If the start input is closed when control voltage is applied, the starter will attempt to start.

Check that the start/stop input is open before applying control voltage.



NOTE

The ASA 4.0 Basic will only accept commands from the control inputs if parameter 1A *Command Source* is set to Digital Input.

4.3.4 Reset/Starter Disable

The reset input (10, 11) is normally closed by default. The ASA 4.0 Basic will not perform a start if the reset input is open. The display will show "Not Ready".

If the reset input opens while the ASA 4.0 Basic is running, the starter will remove power and allow the motor to coast to stop.



NOTE

The reset input can be configured for normally open or normally closed operation. Use parameter 71 *Reset/Enable Logic*.

4.3.5 Programmable Inputs

The programmable inputs (13, 14 and 13, 15) allow external equipment to control the starter.

The operation of the programmable inputs is controlled by parameters 7A-7H.

4.3.6 USB Port

The USB port can be used to upload a configuration file, or download parameter settings and event log information from the starter. Refer to *USB Save & Load* on page 25 for details.

4.4 Outputs

4.4.1 Output Terminals

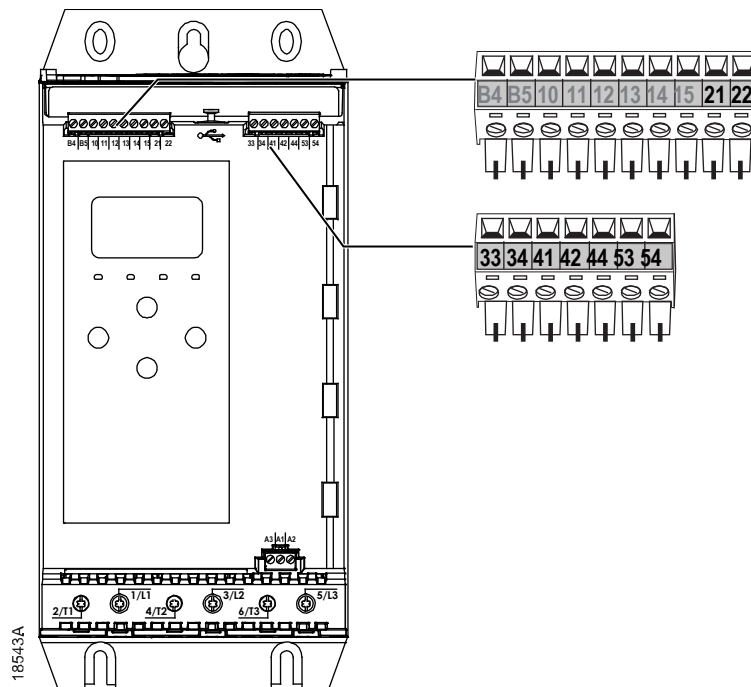

21, 22	Analog output
33, 34	Main contactor output
41, 42, 44	Relay output A (default = Run)
53, 54	Relay output B (default = Run)

4.4.2 Analog Output

The ASA 4.0 Basic has an analog output, which can be connected to associated equipment to monitor motor performance.

The operation of the analog output is controlled by parameters 9A~9D.

4.4.3 Main Contactor Output

The main contactor output (33, 34) closes as soon as the soft starter receives a start command and remains closed while the soft starter is controlling the motor (until the motor starts a coast to stop, or until the end of a soft stop). The main contactor output will also open if the soft starter trips.



CAUTION

Some electronic contactor coils are not suitable for direct switching with PCB mount relays. Consult the contactor manufacturer/supplier to confirm suitability.

4.4.4 Programmable Outputs

The programmable outputs (41, 42, 44 and 53, 54) can report the status of the starter, or can be used to control associated equipment.

The operation of the programmable outputs is controlled by parameters 8A~8F.

4.5 Control Voltage

4.5.1 Control Voltage Terminals

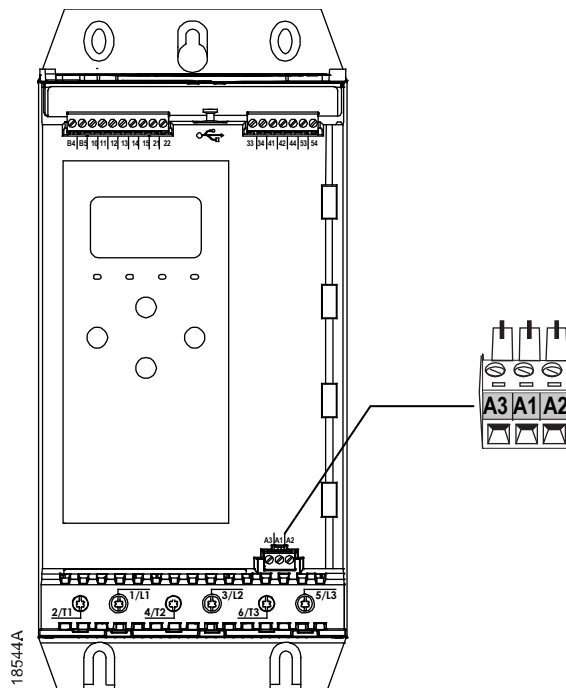

Connect the control supply according to the supply voltage being used.

- ASA4.0-B xxxxB/x/12 (110~120 VAC): A1, A2
- ASA4.0-B xxxxB/x/12 (220~240 VAC): A2, A3
- ASA4.0-B xxxxB/x/14 (24 VAC/VDC): A1, A2

4.5.2 UL Compliant Installation

For models ASA4.0-B 0184B to ASA4.0-B 0580B to be UL compliant, supplementary or branch overcurrent protection must be used on the control circuit supply (A1, A2, A3), in accordance with the electrical code applicable at the installation location.

4.6 Power Terminations



NOTE

Some units use aluminium busbars. When connecting power terminations, we recommend cleaning the surface contact area thoroughly (using an emery or stainless steel brush) and using an appropriate jointing compound to prevent corrosion.

The power input and output terminals are at the bottom of the unit.

- Models ASA4.0-B 0024B~ASA4.0-B 0135B use cage clamps. Use only copper stranded or solid conductors, rated for 75 °C or higher.
- Models ASA4.0-B 0184B~ASA4.0-B 0580B use busbars. Use copper or aluminium conductors, stranded or solid, rated for 60 °C/ 75 °C.

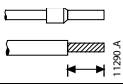
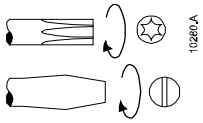
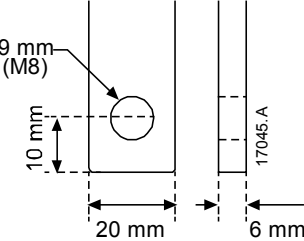
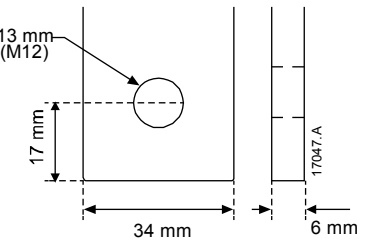
ASA4.0-B 0024B~ASA4.0-B 0135B	
 <p>Cable size: 6-70 mm² (AWG 10-2/0) Torque: 4 Nm (2.9 ft-lb)</p> <p>14 mm (0.55 inch)</p> 	 <p>Torx T20 x 150 Flat 7 mm x 150</p>
ASA4.0-B 0184B~ASA4.0-B 0250B	ASA4.0-B 0352B~ASA4.0-B 0580B
<p>19 Nm (14.0 ft-lb)</p>  <p>9 mm (M8) 10 mm 20 mm 6 mm 17045.A</p>	<p>66 Nm (49.0 ft-lb)</p>  <p>13 mm (M12) 17 mm 34 mm 6 mm 17047.A</p>



NOTE

If the installation requires large diameter cables, it is possible to complete each termination with two smaller cables, one on each side of the busbar.

4.6.1 UL Compliant Installation

For models ASA4.0-B 0184B to ASA4.0-B 0580B to be UL compliant, you must use the recommended pressure terminal/connector.

Model	Recommended lugs part No.
ASA4.0-B 0184B	OPHD 185-10
ASA4.0-B 0200B	
ASA4.0-B 0229B	
ASA4.0-B 0250B	
ASA4.0-B 0352B	OPHD 150-12
ASA4.0-B 0397B	
ASA4.0-B 0410B	
ASA4.0-B 0550B	OPHD 240-12
ASA4.0-B 0580B	

4.6.2 Motor Connection

The ASA 4.0 Basic must be connected to the motor in-line (also called three-wire connection).

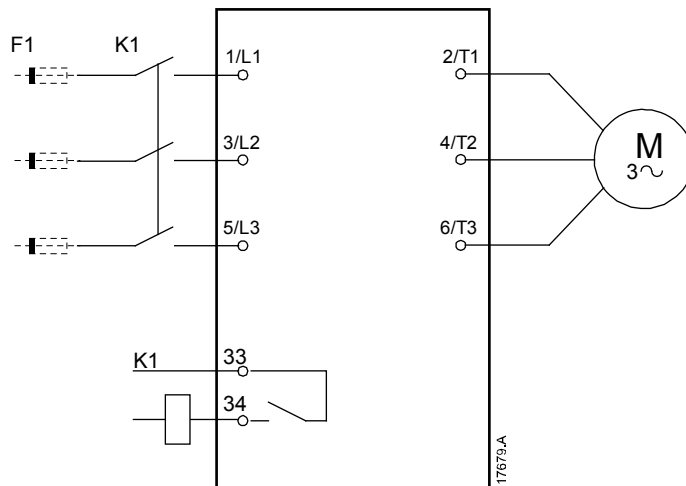

K1	Main contactor (strongly recommended)
F1	Fuses or circuit breaker (optional)
33, 34	Main contactor output

4.7 Typical Installation

The ASA 4.0 Basic is installed with a main contactor (AC3 rated). Control voltage must be supplied from the input side of the contactor. The main contactor is controlled by the main contactor output (33, 34).

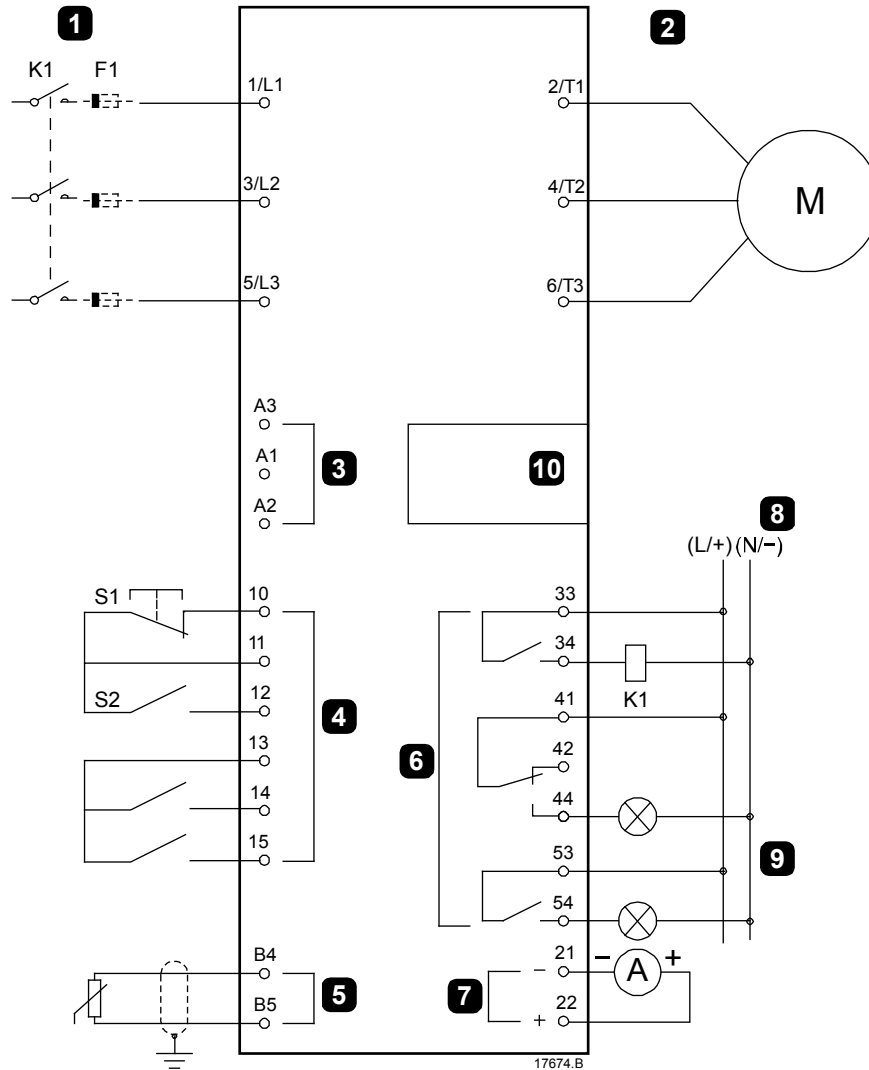

1	Three-phase supply
2	Motor
3	Control voltage (soft starter)
4	Digital inputs
5	Motor thermistor input
6	Relay outputs
7	Analog output
8	Control voltage (external equipment)
9	Pilot lamps
10	Communications / Smart card expansion port

K1	Main contactor
F1	Semiconductor fuses (optional)
10, 11 (S1)	Reset
11, 12 (S2)	Start/Stop
13, 14	Programmable input A (default = Input Trip (N/O))
13, 15	Programmable input B (default = Input Trip (N/O))
B4, B5	Motor thermistor input
33, 34	Main contactor output
41, 42, 44	Relay output A (default = Run)
53, 54	Relay output B (default = Run)
21, 22	Analog output

4.8 Quick Setup

The Quick Setup Menu makes it easy to configure the ASA 4.0 Basic for common applications. The ASA 4.0 Basic guides you through the most common installation parameters, and suggests a typical setting for the application. You can adjust each parameter to suit your exact requirements.

All other parameters remain at default values. To change other parameter values or review the default settings, use the menu (refer to *Parameter List* for details).

Always set parameter 1B *Motor Full Load Current* to match the motor's nameplate full load current.

Application	Start Mode	Start Ramp Time (seconds)	Initial Current (%)	Current Limit (%)	Adaptive Start Profile	Stop Mode	Stop Time (seconds)	Adaptive Stop Profile
Pump Centrifugal	Adaptive Control	10	200	500	Const. accel.	Adaptive Control	15	Const. decel.
Pump bore	Adaptive Control	3	200	500	Const. accel.	Adaptive Control	3	Const. decel.
Pump Hydraulic	Constant Current	2	200	350	n/a	Coast To Stop	n/a	n/a
Fan Damped	Constant Current	2	200	350	n/a	Coast To Stop	n/a	n/a
Fan Undamped	Constant Current	2	200	450	n/a	Coast To Stop	n/a	n/a
Compressor Screw	Constant Current	2	200	400	n/a	Coast To Stop	n/a	n/a
Compressor Recip	Constant Current	2	200	450	n/a	Coast To Stop	n/a	n/a
Conveyor	Constant Current	5	200	450	n/a	Coast To Stop	n/a	n/a
Bow thruster	Constant Current	5	100	400	n/a	Coast To Stop	n/a	n/a
Bandsaw	Constant Current	2	200	450	n/a	Coast To Stop	n/a	n/a



NOTE

The Adaptive Start and Stop Profile settings only apply when using Adaptive Control. The settings are ignored for all other start and stop modes.

5 Setup Tools

Setup Tools includes options to load or save parameters to a backup file, set the starter's network address, check the status of the inputs and outputs, reset the thermal models or test operation using the Run Simulation.

To access the Setup Tools, press **MENU** to open the Menu then select Setup Tools.

5.1 Command Source

The ASA 4.0 Basic can be started and stopped via the digital inputs, remote keypad, communication network or smart card. The command source can be set via the Setup Tools, or using parameter 1A *Command Source*.

If the remote keypad is installed, the **LOCAL/REMOTE** button provides shortcut access to the Command Source function in Setup Tools.

5.2 Commissioning

Commissioning lets the starter be started and stopped via the local keypad. Use the ▲ and ▼ buttons to select a function, then press ► to send the selected command to the starter. The available functions are:

- Quick stop (coast to stop)/Reset
- Start
- Stop

5.3 Run simulation

The run simulation simulates a motor starting, running and stopping to confirm that the soft starter and associated equipment have been installed correctly.



NOTE

The soft starter must be disconnected from mains voltage.
The simulation is only available when the soft starter is in Ready state.

To use the run simulation:

1. Press **MENU** to open the menu then select Setup Tools.
2. Scroll to Run Simulation and press ►.
3. Apply a start command from the selected command source. The ASA 4.0 Basic simulates its pre-start checks and closes the main contactor relay. The Run LED flashes.



NOTE

If mains voltage is connected, an error message is shown.

4. Press ►. The ASA 4.0 Basic simulates starting. The Run LED flashes.
5. Press ►. The ASA 4.0 Basic simulates running.
6. Apply a stop command from the selected command source. The ASA 4.0 Basic simulates stopping. The Run LED flashes.
7. Press ►. The Ready LED flashes and the main contactor relay opens.
8. Press ►. The ASA 4.0 Basic activates then deactivates each programmable output.
9. Press ► to return to the Setup Tools.

```
RUN SIMULATION
READY
APPLY START SIGNAL
```

```
RUN SIMULATION
PRE-START CHECKS
MENU TO CONTINUE
```

```
RUN SIMULATION
ATTENTION!
REMOVE MAINS VOLTS
MENU TO CONTINUE
```

```
RUN SIMULATION
STARTING X:XXS
MENU TO CONTINUE
```

```
RUN SIMULATION
RUNNING
APPLY STOP SIGNAL
```

```
RUN SIMULATION
STOPPING X:XXS
MENU TO CONTINUE
```

```
RUN SIMULATION
STOPPED
MENU TO CONTINUE
```

```
RUN SIMULATION
PROG RELAY A
ON
MENU TO CONTINUE
```

5.4 Load/Save Settings

Load/Save Settings allows users to:

- Reset the ASA 4.0 Basic's parameters to default values
- Load parameter settings from an internal file
- Save the current parameter settings to an internal file

The internal file contains default values until a user file is saved.

To load or save parameter settings:

1. Press **MENU** to open the menu then select Setup Tools.
2. Scroll to Load/Save Settings and press the **▶** button.
3. Scroll to the required function and press the **▶** button.
4. At the confirmation prompt, select YES to confirm or NO to cancel, then press **▶** to proceed.

```
LOAD/SAVE SETTINGS
LOAD DEFAULTS
LOAD USER SET
SAVE USER SET
```

```
LOAD DEFAULTS
NO
YES
```

When the action has been completed, the screen will briefly display a confirmation message, then return to the previous menu level.

5.5 USB Save & Load

The USB Save & Load menu lets you:

- Save parameter settings and all event log entries to an external file (CSV format)
- Save parameter settings to an external file (proprietary format)
- Load parameter settings from a previously saved external file
- Load custom messages to display on the keypad when a programmable input is active



NOTE

The ASA 4.0 Basic supports FAT32 file systems. The ASA 4.0 Basic's USB functions are not compatible with NTFS file systems.

5.5.1 Save & Load Procedure

1. Connect the external drive to the USB port.
2. Press **MENU** to open the menu then select Setup Tools.
3. Scroll to USB Save & Load and press the **▶** button.
4. Scroll to the required function and press the **▶** button.
5. At the confirmation prompt, select YES to confirm or NO to cancel, then press **▶** to proceed.

```
USB SAVE & LOAD
SAVE PARAMS AND LOGS
SAVE MASTER PARAMS
LOAD MASTER PARAMS
```

```
SAVE PARAMS AND LOGS
NO
YES
```

When the action has been completed, the screen will briefly display a confirmation message, then return to the previous menu level.

5.5.2 File Locations and Formats

Save Parameters and Logs: The ASA 4.0 Basic will create a directory at the top level of the USB drive, named with the soft starter's serial number. The event log and parameter settings are saved as individual CSV files, and the soft starter's software and system information are saved to a text file.

Save Master Parameters: The ASA 4.0 Basic will create a file called Master_Parameters.par, in the top level of the USB drive.

Load Master Parameters: The ASA 4.0 Basic will load the file Master_Parameters.par from the top level of the USB drive. This file can be created or edited using WinMaster management software.

Load Custom Message: The ASA 4.0 Basic will load the files Custom_Message_A.txt and Custom_Message_B.txt from the top level of the USB drive.

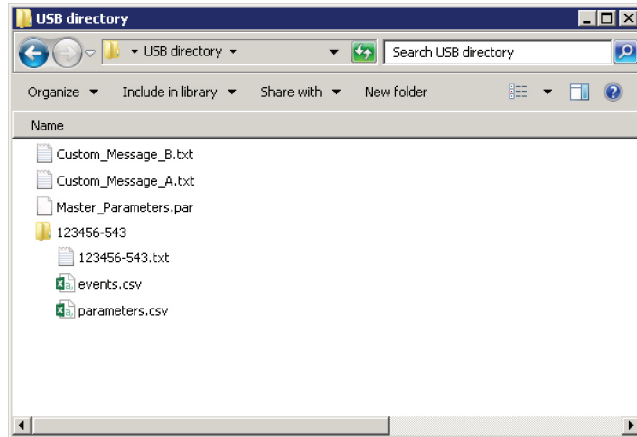

17788.A

5.6 Network Address

To use the ASA 4.0 Basic on an Ethernet network, separate addresses must be configured for:

- IP Address
- Gateway Address
- Subnet Mask

To set the network addresses:

1. Press **MENU** to open the menu then select Setup Tools.
2. Scroll to Network Address and press the **▶** button.
3. Scroll to the required function and press the **▶** button.
4. The first digit of the address will be highlighted.
5. Use **◀** and **▶** to select which digit to alter. Use the **▲** and **▼** buttons to change the value.
6. Press **▶** after the last digit to save the setting.

```
SET IP ADDRESS
192.168.000.002
```

When the action has been completed, the screen will briefly display a confirmation message, then return to the previous menu level.



NOTE
The network address can also be set using parameters 12H~12S.



NOTE
To configure the ASA 4.0 Basic for use with other communication protocols, use parameters 12A~12G.

5.7 Digital I/O State

The top line of the screen shows the start/stop, reset and programmable inputs.
The bottom line of the screen shows the fixed Main Contactor output, then programmable outputs A and B.

```
DIGITAL I/O STATE
INPUTS: 00000000
OUTPUTS: 00000000
```

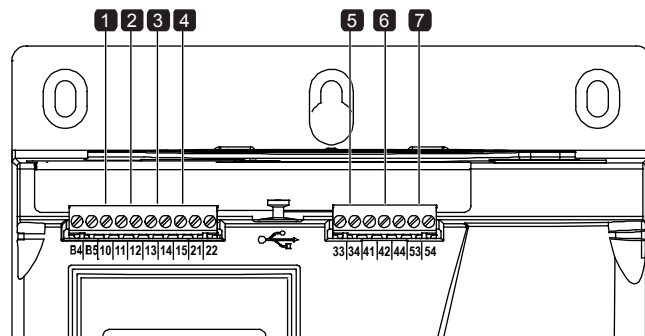

17911.A

1	10, 11: Reset input
2	11, 12: Start/stop input
3	13, 14: Programmable input A
4	13, 15: Programmable input B

5	33, 34: Main contactor output
6	41, 42, 44: Relay output A
7	53, 54: Relay output B

5.8 Analog I/O State

The top line of the screen shows the state of the motor thermistor input.
The bottom line of the screen shows the value of the analog output.

```
ANALOG I/O STATE
THERMISTOR: 0
4-20MA OUTPUT: 04.0 MA
```

Thermistor input:

S = SHORT
H = HOT
C = COLD
O = OPEN

5.9 Serial Number & Rating

The top line of the screen shows the product name.
The middle line shows the unit's serial number.
The bottom line of the screen shows the model number.

```
SERIAL NUMBER & RATING
ASA 4.0 BASIC
123456-123
0410-5-S1-12
```

5.10 Software Versions

The software versions screen reports the version of each software component in the starter:

- user interface
- motor control
- remote keypad (if connected)
- parameter list
- bootloader
- expansion card (if fitted)



NOTE

Updated software, including alternative languages, can be loaded into the starter via the USB port if required. Contact your local supplier for further information.

5.11 Thermistor Reset

The thermistor input is disabled by default, but activates automatically when a thermistor is detected. If thermistors have previously been connected to the ASA 4.0 Basic but are no longer required, use the Thermistor Reset function to disable the thermistor.

5.12 Reset Thermal Model

The soft starter's thermal modelling software constantly monitors the motor's performance. This allows the starter to calculate the motor's temperature and ability to start successfully at any time.

The thermal model can be reset if required.



CAUTION

Resetting the motor thermal model will compromise thermal model protection and may compromise motor life. Only reset the thermal model in an emergency.

6 Logs

The Logs Menu provides information on events, trips and starter performance.

To access the Logs Menu on the local keypad, press **MENU** to open the Menu then select Logs. On the remote keypad, press **LOGS**.

6.1 Event Log

The Event Log stores details of the starter's most recent trips, warnings, and operations (including starts, stops and configuration changes).

Event 1 is the most recent and event 384 is the oldest stored event.



NOTE

Events in the event log are timestamped based on time elapsed since control power was last applied. The timestamp resets to zero when control power is cycled.



NOTE







The event log can be exported to an external file for analysis away from the starter. Refer to *USB Save & Load* on page 25 for details.

6.2 Counters

The counters store statistics on the starter's operation:

- Hours run (lifetime and since counter last reset)
- Number of starts (lifetime and since counter last reset)
- Number of times the thermal model has been reset

To view the counters:

1. Open the Logs.
2. Scroll to counters and press .
3. Use the  and  buttons to scroll through the counters. Press  to view details.
4. To reset a counter, press  then use the  and  buttons to select Reset/Do Not Reset. Press **STORE** to confirm the action.

To close the counter and return to the Logs, press .

6.3 QR Code

The ASA 4.0 Basic can generate a QR code which allows a smartphone to display key information about the starter, including serial number, firmware versions and installed options, plus details of the starter's three most recent trips. This information can be useful when requesting assistance from your local supplier.



NOTE

You must install the soft starter support app in order to read the QR code. Contact your local supplier for further information.

7 Keypad and Feedback

7.1 The Keypad

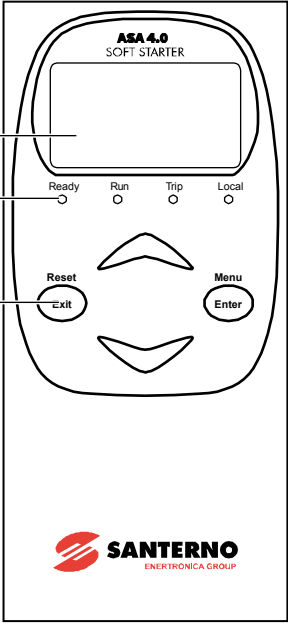
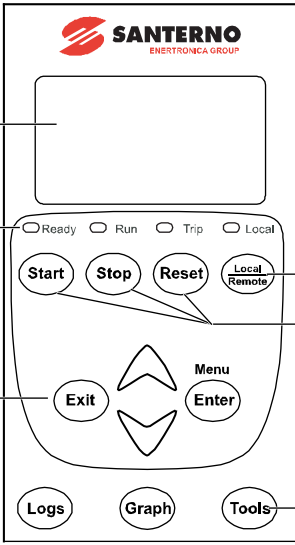
Local keypad	Remote keypad (if installed)
	
1	Four-line display for status and programming details.
2	Status LEDs
3	Menu navigation buttons: ◀: Exit the menu or parameter, or cancel a parameter change. On the local keypad, this button also resets a trip. ▶: Enter a menu or parameter, or save a parameter change. ▲ ▼: Scroll to the next or previous menu or parameter, change the setting of the current parameter or scroll through the status screens.
4	Shortcut to the command source menu in Setup Tools.
5	Soft starter local control buttons
6	Shortcut buttons for quick access to common tasks. LOGS : Open the Logs Menu. GRAPHS : Select which graph to view, or pause/restart the graph (hold longer than 0.5 seconds) TOOLS : Open the Setup Tools.

7.2 Remote Keypad

The remote keypad can be used to control the soft starter if parameter 1A *Command Source* is set to 'Remote Keypad'.

- If the remote keypad is not selected as the command source, the **START**, **STOP** and **RESET** buttons will have no effect.
- The menu navigation buttons and display on the remote keypad are always active.
- If a button is pressed on the starter's local keypad, the display on the remote keypad will update to match.



NOTE

The remote keypad can be safely connected or removed while the starter is running. It is not necessary to remove mains or control voltage.



NOTE

If parameter 1A *Command Source* is set to Remote Keypad, removing the remote keypad will cause a trip.

7.3 Lighten/Darken the Display

The backlight on the display can be adjusted:

- to lighten the display, hold down the ◀ button and press the ▲ key
- to darken the display, hold down the ◀ button and press the ▼ key



NOTE

The local and remote keypads can be adjusted independently.

7.4 Starter status LEDs

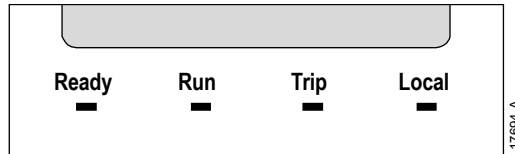

LED name	On	Flashing
Ready	The motor is stopped and the starter is ready to start.	The motor is stopped and the starter is not ready to start: <ul style="list-style-type: none"> waiting for the <i>Restart Delay</i> (parameter 5H) the thermal models indicate the starter and/or motor are too hot to start safely the reset input (10, 11) is open
Run	The motor is in run state (receiving full voltage).	The motor is starting or stopping.
Trip	The starter has tripped.	The starter is in warning state.
Local	The starter is being controlled via a remote keypad.	–

If all LEDs are off, the starter is not receiving control voltage.

7.5 Displays

The keypad displays a wide range of performance information about the soft starter. To scroll through the feedback screens, press the ▲ and ▼ buttons.

7.5.1 Starter information

At power-up, the starter information screen shows details of the starter's rating, software versions and serial number.

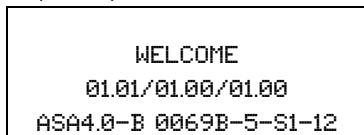

Software versions: user interface, motor control, remote keypad

Model code: current rating, mains voltage, frame size, control voltage

(remote keypad software version is only displayed when a remote keypad is connected)

7.5.2 Starter status screen

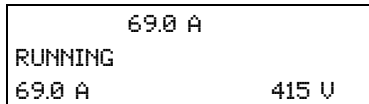

motor running current

Starter status

Parameter 10H *User Parameter 1* and parameter 10I *User Parameter 2*

7.5.3 Current

The current screen shows real-time line current on each phase.

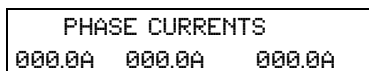

7.5.4 Last Start Information

The last start information screen shows details of the most recent successful start:

- start duration (seconds)
- maximum start current drawn (as a percentage of motor full load current)
- calculated rise in motor temperature

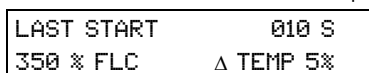

7.5.5 User configurable screen

The programmable screen can be configured to show the most important information for the particular application. Use parameters 10J ~ 10M to select which information to display.

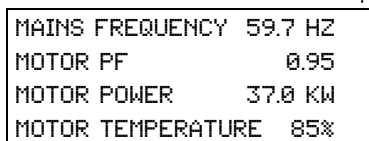

7.5.6 Performance Graph

The performance graph provides a real-time display of operating performance. Use parameters 10B~10E to format the graph.

The display on the main keypad shows information for motor current.

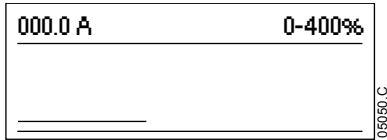

If a remote keypad is connected, press **GRAPHS** to change the graph data. The graph can show:

- motor current
- motor temperature
- motor pf
- analog input data from the smart card (if installed)

8 Operation

8.1 Start, Stop and Reset Commands

The ASA 4.0 Basic can be started and stopped via the digital inputs, remote keypad, communication network or smart card. The command source can be set via the Setup Tools, or using parameter 1A *Command Source*.

- The ASA 4.0 Basic will only accept Start and Reset commands from the designated command source.
- The ASA 4.0 Basic will accept Stop commands from the designated command source, but can be forced to stop by opening the reset input.
- The programmable input can be used to override the selected command source (refer to parameter 7A *Input A Function*).

8.2 Command Override

The programmable input (13, 14) can be used to override the command source, for situations where the normal control mechanism has been lost. Set parameter 7A *Input A Function* to the alternative command source (eg 'Command Override: Keypad').

While the input is active, the starter will only accept commands from the selected override source. To restore control to the command source selected in parameter 1A *Command Source*, reopen the input.

8.3 Emergency Mode

Emergency mode allows the ASA 4.0 Basic to run the motor and ignore trip conditions.

Emergency mode is controlled via a programmable input (input A 13, 14 or input B 13, 15) and parameter 7A *Input A Function*/7E *Input B Function* must be set to 'Emergency Mode'. A closed circuit across 13, 14 activates emergency mode. When the ASA 4.0 Basic receives a start command, it will continue to run until a stop command is received, ignoring all trips and warnings.

Emergency mode can be used in conjunction with any command source.



NOTE

Although emergency mode operation satisfies the functionality requirements of Fire Mode, Santerno does not recommend its use in situations that require testing and/or compliance with specific standards as it is not certified.



CAUTION

Continued use of emergency mode is not recommended. Emergency mode may compromise the starter and/or motor life as all protections and trips are disabled.

Using the starter in emergency mode will void the product warranty.

8.4 Auxiliary Trip

An external trip circuit (such as a low pressure alarm switch for a pumping system) can be used to trip the soft starter and stop the motor. The external circuit is connected to a programmable input (input A 13, 14 or input B 13, 15). To control the behaviour of the trip, set the following parameters:

- Parameter 7A *Input A Function*: select 'Input Trip (N/O)'.
- Parameter 7B *Input A Trip*: set as required. For example, 'Run Only' limits the input trip to when the soft starter is running only.
- Parameter 7C *Input A Trip Delay*: sets a delay between the input activating and the soft starter tripping.
- Parameter 7D *Input A Initial Delay*: sets a delay before the soft starter monitors the state of the input, after the start signal. For example, a delay may be required to allow time for pipeline pressure to build up.
- Parameter 7J *Input A Name*: select a name, eg 'Input A Trip' (optional).

8.5 Typical Control Methods

The requirements of an application differ between each installation, but the methods listed below are often a good starting point for common applications.

Application	Start Mode	Start Ramp Time (seconds)	Initial Current (%FLC)	Current Limit (%FLC)	Stop Mode	Stop Time (seconds)
Bow thruster	Constant Current	5	100	400	Coast To Stop	n/a
Centrifuge (Separator)	Constant Current	1	200	450	Coast To Stop	n/a
Chipper	Constant Current	1	200	450	Coast To Stop	n/a
Compressor - reciprocating - loaded	Constant Current	1	200	450	Coast To Stop	n/a
Compressor - reciprocating - unloaded	Constant Current	1	200	400	Coast To Stop	n/a
Compressor - screw - loaded	Constant Current	1	200	400	Coast To Stop	n/a
Compressor - screw - unloaded	Constant Current	1	200	350	Coast To Stop	n/a
Conveyor - horizontal	Constant Current	5	200	400	TVR Soft Stop	10
Conveyor - inclined	Constant Current	2	200	450	Coast To Stop	n/a
Conveyor - vertical (bucket)	Constant Current	2	200	450	Coast To Stop	n/a
Crusher - cone	Constant Current	1	200	350	Coast To Stop	n/a
Crusher - jaw	Constant Current	1	200	450	Coast To Stop	n/a
Crusher - rotary	Constant Current	1	200	400	Coast To Stop	n/a
Debarker	Constant Current	1	200	350	Coast To Stop	n/a
Fan - axial (damped)	Constant Current	1	200	350	Coast To Stop	n/a
Fan - axial (undamped)	Constant Current	1	200	450	Coast To Stop	n/a
Fan - centrifugal (damped)	Constant Current	1	200	350	Coast To Stop	n/a
Fan - centrifugal (undamped)	Constant Current	1	200	450	Coast To Stop	n/a
Fan - high pressure	Constant Current	1	200	450	Coast To Stop	n/a
Mill - ball	Constant Current	1	200	450	Coast To Stop	n/a
Mill - hammer	Constant Current	1	200	450	Coast To Stop	n/a
Pump - bore	Adaptive Control (Const. accel.)	3	n/a	500	Adaptive Control (Const. decel.)	3
Pump - centrifugal	Adaptive Control (Const. accel.)	10	n/a	500	Adaptive Control (Const. decel.)	15
Pump - Hydraulic	Constant Current	2	200	350	Coast To Stop	n/a
Pump - positive displacement	Adaptive Control (Const. accel.)	10	n/a	400	Adaptive Control (Const. decel.)	10
Pump - submersible	Adaptive Control (Const. accel.)	5	n/a	500	Adaptive Control (Const. decel.)	5
Saw - bandsaw	Constant Current	1	200	450	Coast To Stop	n/a
Saw - circular	Constant Current	1	200	350	Coast To Stop	n/a
Shredder	Constant Current	1	200	450	Coast To Stop	n/a

8.6 Soft Start Methods

8.6.1 Constant Current

Constant current is the traditional form of soft starting, which raises the current from zero to a specified level and keeps the current stable at that level until the motor has accelerated.

Constant current starting is ideal for applications where the start current must be kept below a particular level.

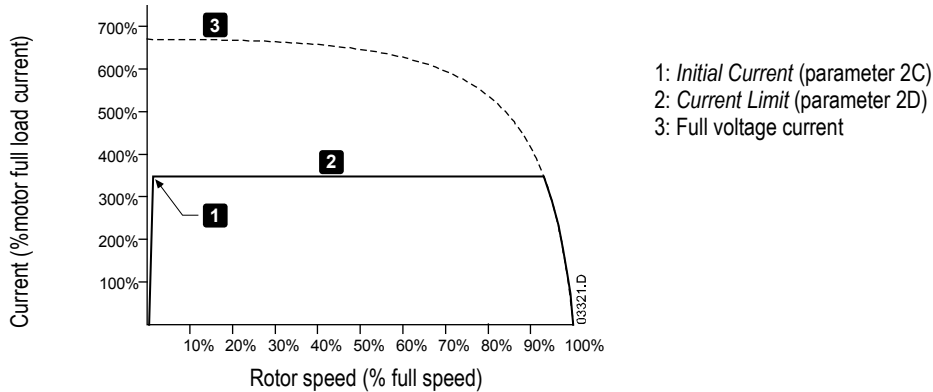

8.6.2 Constant Current with Current Ramp

Current ramp soft starting raises the current from a specified starting level (1) to a maximum limit (3), over an extended period of time (2).

Current ramp starting can be useful for applications where:

- the load can vary between starts (for example a conveyor which may start loaded or unloaded). Set the initial current (parameter 2C) to a level that will start the motor with a light load, and the current limit (parameter 2D) to a level that will start the motor with a heavy load.
- the load breaks away easily, but starting time needs to be extended (for example a centrifugal pump where pipeline pressure needs to build up slowly).
- the electricity supply is limited (for example a generator set), and a slower application of load will allow greater time for the supply to respond.

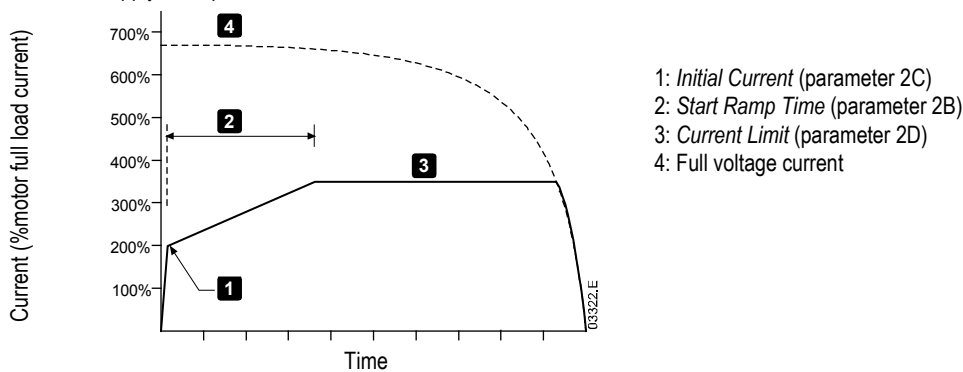

8.6.3 Adaptive Control for Starting

In an adaptive control soft start, the ASA 4.0 Basic adjusts the current in order to start the motor within a specified time.



NOTE

The ASA 4.0 Basic will apply the current limit on all soft starts, including adaptive control. If the current limit is too low or the start ramp time (parameter 2B) is too short, the motor may not start successfully.

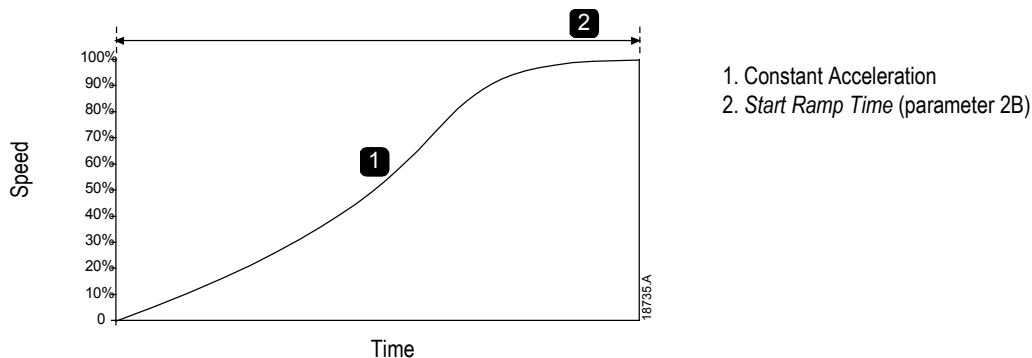

Fine-tuning Adaptive Control

If the motor does not start or stop smoothly, adjust the adaptive control gain (parameter 2I). The gain setting determines how much the ASA 4.0 Basic will adjust future adaptive control starts and stops, based on information from the previous start. The gain setting affects both starting and stopping performance.

- If the motor accelerates or decelerates too quickly at the end of a start or stop, increase the gain setting by 5%~10%.
- If the motor speed fluctuates during starting or stopping, decrease the gain setting slightly.



NOTE

The ASA 4.0 Basic tunes Adaptive Control to match the motor. Changing the following parameters will reset Adaptive Control and the first start/stop cycle will use constant current start/timed voltage ramp stop: 1B *Motor Full Load Current*, 2D *Current Limit*, 2I *Adaptive Control Gain*.

8.7 Stop Methods

8.7.1 Coast to Stop

Coast to stop lets the motor slow at its natural rate, with no control from the soft starter. The time required to stop will depend on the type of load.

8.7.2 Timed Voltage Ramp Soft Stop

Timed voltage ramp stopping reduces the voltage to the motor gradually over a defined time. This can extend the stopping time of the motor and may avoid transients on generator set supplies.



NOTE

The load may continue to run after the stop ramp is complete.

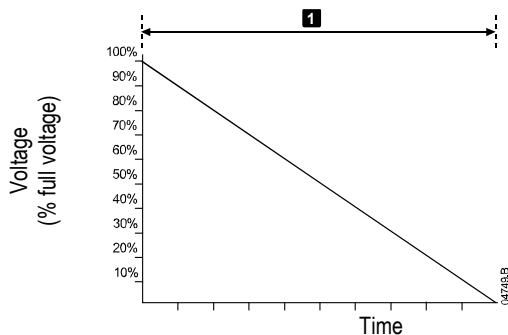

1: Stop Time (parameter 2J)

8.7.3 Adaptive Control for Stopping

In an adaptive control soft stop, the ASA 4.0 Basic controls the current in order to stop the motor within a specified time. Adaptive Control can be useful in extending the stopping time of low inertia loads.

If adaptive control is selected, the first soft stop will use timed voltage ramp. This allows the ASA 4.0 Basic to learn the characteristics of the connected motor. This motor data is used by the ASA 4.0 Basic during subsequent adaptive control stops.



CAUTION

Adaptive Control controls the motor's speed profile, within the programmed time limit. This may result in a higher level of current than traditional control methods.

If replacing a motor connected to an ASA 4.0 Basic programmed for Adaptive Control starting or stopping, the starter will need to learn the characteristics of the new motor. Change the value of parameter 1B *Motor Full Load Current* or parameter 2I *Adaptive Control Gain* to initiate the re-learning process. The next start will use constant current and the next stop will use timed voltage ramp.

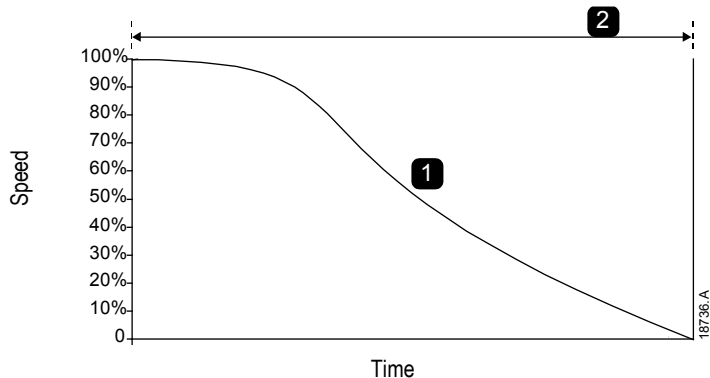

1. Constant Deceleration
2. Stop Time (parameter 2G)

Adaptive Control is ideal for pumping applications, where it can minimise the damaging effects of fluid hammer.

9 Programmable Parameters

9.1 Main Menu

The main menu lets you view and change programmable parameters that control how the ASA 4.0 Basic operates.

To open the main menu, press the **MENU/ENTER** button then scroll to Main Menu and press **MENU/ENTER** again.



NOTE

Parameters for smart card functions are only visible in the parameter list if the smart card is installed.

9.2 Altering Parameter Values

To change a parameter value:

- scroll to the appropriate parameter in the main menu and press **▶** to enter edit mode.
- to alter the parameter setting, use the **▲** and **▼** buttons. Pressing **▲** or **▼** once will increase or decrease the value by one unit. If the button is held for longer than five seconds, the value will increase or decrease at a faster rate.
- to save changes, press **STORE**. The setting shown on the display will be saved and the keypad will return to the parameter list.
- to cancel changes, press **EXIT**. The keypad will ask for confirmation, then return to the parameter list without saving changes.

9.3 Adjustment Lock

You can prevent users from altering parameter settings by turning on the adjustment lock (parameter 10G *Adjustment Lock*).

If a user attempts to change a parameter value when the adjustment lock is active, an error message is displayed:

ACCESS DENIED
ADJ LOCK IS ON

9.4 Parameter List

	Parameter Group	Default Setting
1	Motor Details	
1A	<i>Command Source</i>	Digital Input
1B	<i>Motor Full Load Current</i>	Model dependent
1C	<i>Locked Rotor Time</i>	00:10 (mm:ss)
1D	<i>Locked Rotor Current</i>	600%
1E	<i>Motor Service Factor</i>	105%
1F	<i>Reserved</i>	
2	Motor Start/Stop	
2A	<i>Start Mode</i>	Constant Current
2B	<i>Start Ramp Time</i>	00:10 (mm:ss)
2C	<i>Initial Current</i>	200%
2D	<i>Current Limit</i>	350%
2E	<i>Adaptive Start Profile</i>	Constant Acceleration
2F	<i>Stop Mode</i>	TVR Soft Stop
2G	<i>Stop Time</i>	00:00 (mm:ss)
2H	<i>Adaptive Stop Profile</i>	Constant Deceleration
2I	<i>Adaptive Control Gain</i>	75%
2J	<i>Multi Pump</i>	Single Pump
2K	<i>Start Delay</i>	00:00 (mm:ss)
5	Protection Levels	
5A	<i>Current Imbalance</i>	30%
5B	<i>Current Imbalance Delay</i>	00:03 (mm:ss)
5C	<i>Undercurrent</i>	20%
5D	<i>Undercurrent Delay</i>	00:05 (mm:ss)
5E	<i>Overcurrent</i>	400%
5F	<i>Overcurrent Delay</i>	00:00 (mm:ss)
5G	<i>Excess Start Time</i>	00:20 (mm:ss)
5H	<i>Restart Delay</i>	00:10 (mm:ss)
5I	<i>Starts per Hour</i>	0
5J	<i>Phase Sequence</i>	Any Sequence

	Parameter Group	Default Setting
6	Protection Actions	
6A	<i>Auto-Reset Count</i>	0
6B	<i>Auto-Reset Delay</i>	00:05 (mm:ss)
6C	<i>Current Imbalance</i>	Soft Trip and Log
6D	<i>Undercurrent</i>	Soft Trip and Log
6E	<i>Overcurrent</i>	Soft Trip and Log
6F	<i>Excess Start Time</i>	Soft Trip and Log
6G	<i>Input A Trip</i>	Soft Trip and Log
6H	<i>Input B Trip</i>	Soft Trip and Log
6I	<i>Network Communications</i>	Soft Trip and Log
6J	<i>Remote Keypad Fault</i>	Soft Trip and Log
6K	<i>Frequency</i>	Soft Trip and Log
6L	<i>Phase Sequence</i>	Soft Trip and Log
6M	<i>Motor Overtemperature</i>	Soft Trip and Log
6N	<i>Motor Thermistor Circuit</i>	Soft Trip and Log
7	Inputs	
7A	<i>Input A Function</i>	Input Trip (N/O)
7B	<i>Input A Trip</i>	Operating Only
7C	<i>Input A Trip Delay</i>	00:00 (mm:ss)
7D	<i>Input A Initial Delay</i>	00:00 (mm:ss)
7E	<i>Input B Function</i>	Input Trip (N/O)
7F	<i>Input B Trip</i>	Operating Only
7G	<i>Input B Trip Delay</i>	00:00 (mm:ss)
7H	<i>Input B Initial Delay</i>	00:00 (mm:ss)
7I	<i>Reset/Enable Logic</i>	Normally Closed (N/C)
7J	<i>Input A Name</i>	Input A Trip
7K	<i>Input B Name</i>	Input B Trip
8	Relay Outputs	
8A	<i>Relay A Function</i>	Run
8B	<i>Relay A On Delay</i>	00:00 (mm:ss)
8C	<i>Relay A Off Delay</i>	00:00 (mm:ss)
8D	<i>Relay B Function</i>	Run
8E	<i>Relay B On Delay</i>	00:00 (mm:ss)
8F	<i>Relay B Off Delay</i>	00:00 (mm:ss)
8G	<i>Low Current Flag</i>	50%
8H	<i>High Current Flag</i>	100%
8I	<i>Motor Temperature Flag</i>	80%
8J	<i>Main Contactor Time</i>	400 ms
9	Analog Output	
9A	<i>Analog Output A</i>	Current (% FLC)
9B	<i>Analog A Scale</i>	4-20 mA
9C	<i>Analog A Maximum Adjustment</i>	100%
9D	<i>Analog A Minimum Adjustment</i>	000%
10	Display	
10A	<i>Language</i>	English
10B	<i>Temperature Scale</i>	Celsius
10C	<i>Graph Timebase</i>	30 seconds
10D	<i>Graph Maximum Adjustment</i>	400%
10E	<i>Graph Minimum Adjustment</i>	0%
10F	<i>Current Calibration</i>	100%
10G	<i>Adjustment Lock</i>	Read & Write
10H	<i>User Parameter 1</i>	Current
10I	<i>User Parameter 2</i>	Mains Frequency
10J	<i>User Parameter 3</i>	Motor pf
10K	<i>User Parameter 4</i>	Motor Temperature (%)
10L	<i>User Parameter 5</i>	Hours Run
10M	<i>User Parameter 6</i>	Number of Starts

	Parameter Group	Default Setting
12	Communications Card	
12A	Modbus Address	1
12B	Modbus Baud Rate	9600
12C	Modbus Parity	None
12D	Modbus Timeout	Off
12E	Devicenet Address	0
12F	Devicenet Baud Rate	125kB
12G	Profibus Address	1
12H	Gateway Address	192
12I	Gateway Address 2	168
12J	Gateway Address 3	0
12K	Gateway Address 4	100
12L	IP Address	192
12M	IP Address 2	168
12N	IP Address 3	0
12O	IP Address 4	2
12P	Subnet Mask	255
12Q	Subnet Mask 2	255
12R	Subnet Mask 3	255
12S	Subnet Mask 4	0
12T	DHCP	Disable
12U	Location ID	0
20	Advanced	
20A	Tracking Gain	50%
20B	Pedestal Detect	80%
20C	Bypass Contactor Delay	150 ms
20D	Model Rating	Model dependent
20E	Screen Timeout	1 minute
20F	Motor Connection	Auto-detect
30	Pump Input Configuration	
30A	Pressure Sensor Type	None
30B	Pressure Units	kPa
30C	Pressure at 4 mA	0
30D	Pressure at 20 mA	0
30E	Flow Sensor Type	None
30F	Flow Units	litres/second
30G	Flow at 4 mA	0
30H	Flow at 20 mA	0
30I	Units per Minute at Max Flow	0
30J	Pulses per Minute at Max Flow	0
30K	Units per Pulse	0
30L	Depth Sensor Type	None
30M	Depth Units	metres
30N	Depth at 4 mA	0
30O	Depth at 20 mA	0
31	Flow Protection	
31A	High Flow Trip Level	10
31B	Low Flow Trip Level	5
31C	Flow Start Delay	00:00:500 (mm:ss:ms)
31D	Flow Response Delay	00:00:500 (mm:ss:ms)
32	Pressure Protection	
32A	High Pressure Trip Level	10
32B	High Pressure Start Delay	00:00:500 (mm:ss:ms)
32C	High Pressure Response Delay	00:00:500 (mm:ss:ms)
32D	Low Pressure Trip Level	5
32E	Low Pressure Start Delay	00:00:500 (mm:ss:ms)
32F	Low Pressure Response Delay	00:00:500 (mm:ss:ms)

	Parameter Group	Default Setting
33	Pressure Control	
33A	Pressure Control Mode	Off
33B	Start Pressure Level	5
33C	Start Response Delay	00:00:500 (mm:ss:ms)
33D	Stop Pressure Level	10
33E	Stop Response Delay	00:00:500 (mm:ss:ms)
34	Depth Protection	
34A	Depth Trip Level	5
34B	Depth Reset Level	10
34C	Depth Start Delay	00:00:500 (mm:ss:ms)
34D	Depth Response Delay	00:00:500 (mm:ss:ms)
35	Thermal Protection	
35A	Temperature Sensor Type	None
35B	Temperature Trip Level	40
36	Pump Trip Action	
36A	Pressure Sensor	Soft Trip and Log
36B	Flow Sensor	Soft Trip and Log
36C	Depth Sensor	Soft Trip and Log
36D	High Pressure	Soft Trip and Log
36E	Low Pressure	Soft Trip and Log
36F	High Flow	Soft Trip and Log
36G	Low Flow	Soft Trip and Log
36H	Flow Switch	Soft Trip and Log
36I	Well Depth	Soft Trip and Log
36J	RTD/PT100 B	Soft Trip and Log

9.5 1 Motor Details

1A – Command Source

Options:	Digital Input (default)	The ASA 4.0 Basic will accept start and stop commands from the digital inputs.
	Network	The ASA 4.0 Basic will accept start and stop commands from the communication expansion card.
	Remote Keypad	The ASA 4.0 Basic will accept start and stop commands from the Remote Keypad.
	Smart Card	The ASA 4.0 Basic will accept start and stop commands from the smart card.
Description:	Selects the command source for controlling the soft starter.	

1B – Motor Full Load Current

Range:	Model dependent
Description:	Matches the starter to the connected motor's full load current. Set to the full load current (FLC) rating shown on the motor nameplate.

1C – Locked Rotor Time

Range:	0:01 - 2:00 (minutes:seconds)	Default:	10 seconds
Description:	Sets the maximum length of time the motor can sustain locked rotor current from cold before reaching its maximum temperature. Set according to the motor datasheet.		

1D – Locked Rotor Current

Range:	400% - 1200% FLC	Default:	600%
Description:	Sets the locked rotor current of the connected motor, as a percentage of full load current. Set according to the motor datasheet.		

1E – Motor Service Factor

Range:	100% - 130%	Default:	105%
Description:	Sets the motor service factor used by the thermal model. If the motor runs at full load current, it will reach 100%. Set according to the motor datasheet.		



NOTE

Parameters 1C, 1D and 1E determine the trip current for motor overload protection. The default settings of parameters 1C, 1D and 1E provide Motor Overload Protection: Class 10, Trip Current 105% of FLA (full load amperage) or equivalent.

1F – Reserved

Description: This parameter is reserved for future use.

9.6

2 Motor Start/Stop

2A – Start Mode

Options: Constant Current (default)
Adaptive Control

Description: Selects the soft start mode.



NOTE

The ASA 4.0 Basic will apply the current limit on all soft starts, including adaptive control. If the current limit is too low or the start ramp time (parameter 2B) is too short, the motor may not start successfully.

2B – Start Ramp Time

Range: 0:01 - 3:00 (minutes:seconds) **Default:** 10 seconds

Description: Sets the total start time for an Adaptive Control start or the ramp time for current ramp starting (from the initial current to the current limit).

2C – Initial Current

Range: 100% - 600% FLC **Default:** 200%

Description: Sets the initial start current level for current ramp starting, as a percentage of motor full load current. Set so that the motor begins to accelerate immediately after a start is initiated. If current ramp starting is not required, set the initial current equal to the current limit.

2D – Current Limit

Range: 100% - 600% FLC **Default:** 350%

Description: Sets the current limit for constant current and current ramp soft starting, as a percentage of motor full load current.

2E – Adaptive Start Profile

Options: Constant Acceleration (default)

Description: Selects which profile the ASA 4.0 Basic will use for an Adaptive Control soft start.



NOTE

The ASA 4.0 Basic will apply the current limit on all soft starts, including adaptive control. If the current limit is too low or the start ramp time (parameter 2B) is too short, the motor may not start successfully.

2F – Stop Mode

Options: Coast To Stop
TVR Soft Stop (default)
Adaptive Control

Description: Selects the stop mode.

2G – Stop Time

Range: 0:00 - 4:00 (minutes:seconds) **Default:** 0 second

Description: Sets the time for soft stopping the motor using timed voltage ramp or Adaptive Control. If a main contactor is installed, the contactor must remain closed until the end of the stop time. Use the main contactor output (33, 34) to control the main contactor.

2H – Adaptive Stop Profile

Options: Constant Deceleration (default)

Description: Selects which profile the ASA 4.0 Basic will use for an Adaptive Control soft stop.

2I – Adaptive Control Gain

Range: 1% - 200% **Default:** 75%

Description: Adjusts the performance of Adaptive Control. This setting affects both starting and stopping control.

2J – Multi Pump

Options: Single Pump (default)
Manifold Pump

Description: Adjusts the performance of adaptive control to suit installations with multiple pumps connected to a common outlet manifold.

2K – Start Delay

Range: 0:00 - 60:00 (minutes:seconds) **Default:** 0 second

Description: Sets a delay after the starter receives a start command, before it starts the motor.

9.7 5 Protection Levels

5A – Current Imbalance

Range: 10% - 50% **Default:** 30%

Description: Sets the trip point for current imbalance protection.

5B – Current Imbalance Delay

Range: 0:00 - 4:00 (minutes:seconds) **Default:** 3 seconds

Description: Slows the ASA 4.0 Basic's response to current imbalance, avoiding trips due to momentary fluctuations.

5C – Undercurrent

Range: 0% - 100% **Default:** 20%

Description: Sets the trip point for undercurrent protection, as a percentage of motor full load current. Set to a level between the motor's normal working range and the motor's magnetising (no load) current (typically 25% to 35% of full load current). A setting of 0% disables undercurrent protection.

5D – Undercurrent Delay

Range: 0:00 - 4:00 (minutes:seconds) **Default:** 5 seconds

Description: Slows the ASA 4.0 Basic's response to undercurrent, avoiding trips due to momentary fluctuations.

5E – Overcurrent

Range: 80% - 600% **Default:** 400%

Description: Sets the trip point for overcurrent protection, as a percentage of motor full load current.

5F – Overcurrent Delay

Range: 0:00 - 1:00 (minutes:seconds) **Default:** 0 second

Description: Slows the ASA 4.0 Basic's response to overcurrent, avoiding trips due to momentary overcurrent events.

5G – Excess Start Time

Range: 0:00 - 4:00 (minutes:seconds) **Default:** 20 seconds

Description: Excess start time is the maximum time the ASA 4.0 Basic will attempt to start the motor. If the motor does not transition to Run mode within the programmed limit, the starter will trip. Set for a period slightly longer than required for a normal healthy start. A setting of 0 disables excess start time protection.

5H – Restart Delay

Range: 00:01 - 60:00 (minutes:seconds) **Default:** 10 seconds

Description: The ASA 4.0 Basic can be configured to force a delay between the end of a stop and the beginning of the next start. During the restart delay period, the display shows the time remaining before another start can be attempted.

5I – Starts per Hour

Range: 0 - 10 **Default:** 0

Description: Sets the maximum number of starts the ASA 4.0 Basic will attempt in a 60 minute period. A setting of 0 disables this protection.

5J – Phase Sequence

Options: Any Sequence (default)
Positive Only
Negative Only

Description: Selects which phase sequences the soft starter will allow at a start. During its pre-start checks, the starter examines the sequence of the phases at its input terminals and trips if the actual sequence does not match the selected option.

9.8 6 Protection Action

6A – Auto-Reset Count

Range: 0 – 5 **Default:** 0

Description: Sets how many times the soft starter will auto-reset, if it continues to trip. The reset counter increases by one each time the soft starter auto-resets, and resets after a successful start. Setting 6A to zero disables auto-reset.

6B – Auto-Reset Delay

Range: 0:05 - 15:00 (minutes:seconds) **Default:** 5 seconds

Description: Sets a delay before the soft starter will auto-reset a trip.

6C – Current Imbalance

Options:	Soft Trip and Log (default)	The soft starter will stop the motor as selected in parameter 2F <i>Stop Mode</i> , then enter trip state. The trip must be reset before the ASA 4.0 Basic can restart.
	Soft Trip and Reset	The soft starter will stop the motor as selected in parameter 2F <i>Stop Mode</i> , then enter trip state. The trip will reset after the auto-reset delay.
	Trip Starter	The soft starter will remove power and the motor will coast to stop. The trip must be reset before the ASA 4.0 Basic can restart.
	Trip and Reset	The soft starter will remove power and the motor will coast to stop. The trip will reset after the auto-reset delay.
	Warn and Log	The protection will be written to the event log and the display will show a warning message, but the soft starter will continue to operate.
	Log Only	The protection will be written to the event log but the soft starter will continue to operate.

Description: Selects the soft starter's response to each protection. All protection events are written to the event log.

6D – Undercurrent

Options:	Soft Trip and Log (default)	Trip and Reset
	Soft Trip and Reset	Warn and Log
	Trip Starter	Log Only

Description: Selects the soft starter's response to the protection event.

6E – Overcurrent

Options:	Soft Trip and Log (default)	Trip and Reset
	Soft Trip and Reset	Warn and Log
	Trip Starter	Log Only

Description: Selects the soft starter's response to the protection event.

6F – Excess Start Time

Options:	Soft Trip and Log (default)	Trip and Reset
	Soft Trip and Reset	Warn and Log
	Trip Starter	Log Only

Description: Selects the soft starter's response to the protection event.

6G – Input A Trip

Options:	Soft Trip and Log (default)	Trip and Reset
	Soft Trip and Reset	Warn and Log
	Trip Starter	Log Only

Description: Selects the soft starter's response to the protection event.

6H – Input B Trip

Options:	Soft Trip and Log (default)	Trip and Reset
	Soft Trip and Reset	Warn and Log
	Trip Starter	Log Only

Description: Selects the soft starter's response to the protection event.

6I – Network Communications

Options:	Soft Trip and Log (default)	Warn and Log
	Soft Trip and Reset	Log Only
	Trip Starter	Stop
	Trip and Reset	

Description: Selects the soft starter's response to the protection event. If set to Stop, the ASA 4.0 Basic will perform a soft stop, then can be restarted without a reset.

6J – Remote Keypad Fault

Options:	Soft Trip and Log (default)	Trip and Reset
	Soft Trip and Reset	Warn and Log
	Trip Starter	Log Only

Description: Selects the soft starter's response to the protection event.

6K – Frequency

Options:	Soft Trip and Log (default)	Trip and Reset
	Soft Trip and Reset	Warn and Log
	Trip Starter	Log Only

Description: Selects the soft starter's response to the protection event.

6L – Phase Sequence

Options:	Soft Trip and Log (default)	Trip and Reset
	Soft Trip and Reset	Warn and Log
	Trip Starter	Log Only

Description: Selects the soft starter's response to the protection event.

6M – Motor Overtemperature

Options:	Soft Trip and Log (default)	Trip and Reset
	Soft Trip and Reset	Warn and Log
	Trip Starter	Log Only

Description: Selects the soft starter's response to the protection event.

6N – Motor Thermistor Circuit

Options:	Soft Trip and Log (default)	Trip and Reset
	Soft Trip and Reset	Warn and Log
	Trip Starter	Log Only

Description: Selects the soft starter's response to the protection event.

9.9

7 Inputs

7A – Input A Function

Options:	Command Override: Network	Overrides the setting of 1A and sets the command source to the communications network.
	Command Override: Digital	Overrides the setting of 1A and sets the command source to the digital inputs.
	Command Override: Keypad	Overrides the setting of 1A and sets the command source to the remote keypad.
	Input Trip (N/O) (default)	A closed circuit across 13, 14 trips the soft starter.
	Input Trip (N/C)	An open circuit across 13, 14 trips the soft starter.

Emergency Mode
A closed circuit across 13, 14 activates emergency mode. When the ASA 4.0 Basic receives a start command, it will continue to run until a stop command is received, ignoring all trips and warnings.

Description: Selects the function of Input A.

7B – Input A Trip

Options: Always Active A trip can occur at any time when the soft starter is receiving power.
 Operating Only (default) A trip can occur while the soft starter is running, stopping or starting.
 Run Only A trip can only occur while the soft starter is running.

Description: Selects when an input trip can occur.

7C – Input A Trip Delay

Range: 0:00 - 4:00 (minutes:seconds) **Default:** 0 second

Description: Sets a delay between the input activating and the soft starter tripping.

7D – Input A Initial Delay

Range: 00:00 - 30:00 (minutes:seconds) **Default:** 0 second

Description: Sets a delay before an input trip can occur. The initial delay is counted from the time a start signal is received. The state of the input is ignored until the initial delay has elapsed.

7E – Input B Function

Options: Input Trip (N/O) (default)
 Input Trip (N/C)
 Emergency Mode

Description: Selects the function of Input B. Refer to parameter 7A *Input A Function* for details.

7F – Input B Trip

Options: Always Active
 Operating Only (default)
 Run Only

Description: Selects when an input trip can occur.

7G – Input B Trip Delay

Range: 0:00 - 4:00 (minutes:seconds) **Default:** 0 second

Description: Sets a delay between the input activating and the soft starter tripping.

7H – Input B Initial Delay

Range: 00:00 - 30:00 (minutes:seconds) **Default:** 0 second

Description: Sets a delay before an input trip can occur. The initial delay is counted from the time a start signal is received. The state of the input is ignored until the initial delay has elapsed.

7I – Reset/Enable Logic

Options: Normally Closed (default)
 Normally Open

Description: Selects whether the reset input (10, 11) is normally open or normally closed.



NOTE
 If the reset input is active, the starter will not operate.

7J – Input A Name

Options: Input A Trip (default) Controller
 Low Pressure PLC
 High Pressure Vibration Alarm
 Pump Fault Field Trip
 Low Level Interlock Trip
 High Level Motor Temperature
 No Flow Motor Protection
 Starter Disable Feeder Protection
 Custom Message

Description: Selects a message for the keypad to display when Input A is active.

The custom message can be loaded via the USB port. Refer to *USB Save & Load* on page 25 for details.

7K – Input B Name

Options:	Input B Trip (default)	Controller
	Low Pressure	PLC
	High Pressure	Vibration Alarm
	Pump Fault	Field Trip
	Low Level	Interlock Trip
	High Level	Motor Temperature
	No Flow	Motor Protection
	Starter Disable	Feeder Protection
		Custom Message

Description: Selects a message for the keypad to display when Input B is active.

9.10 8 Relay Outputs

8A – Relay A Function

Options:	Off	Relay A is not used.
	Ready	The relay is closed when the starter is in Ready state.
	Run (default)	The Run output closes when the soft start is complete (when the starting current falls below 120% of the programmed motor full load current) and remains closed until the beginning of a stop (either soft stop or coast to stop).
	Warning	The relay closes when the starter issues a warning (refer to 6 Protection Action on page 42).
	Trip	The relay closes when the starter trips (refer to 6 Protection Action on page 42).
	Low Current Flag	The relay closes when the low current flag activates while the motor is running (refer to parameter 8G Low Current Flag).
	High Current Flag	The relay closes when the high current flag activates while the motor is running (refer to parameter 8H High Current Flag).
	Motor Temperature Flag	The relay closes when the motor temperature flag activates (refer to parameter 8I Motor Temperature Flag).

Description: Selects the function of Relay A. Relay A is a changeover relay.

8B – Relay A On Delay

Range:	0:00 - 5:00 (minutes:seconds)	Default:	0 second
Description:	Sets the delay for changing the state of Relay A.		

8C – Relay A Off Delay

Range:	0:00 - 5:00 (minutes:seconds)	Default:	0 second
Description:	Sets the delay for changing the state of Relay A.		

8D – Relay B Function

Options:	Off	Trip
	Ready	Low Current Flag
	Run (default)	High Current Flag
	Warning	Motor Temperature Flag
Description:	Selects the function of Relay B (normally open). Refer to parameter 8A Relay A Function for details.	

8E – Relay B On Delay

Range:	0:00 - 5:00 (minutes:seconds)	Default:	0 second
Description:	Sets the delay for closing Relay B.		

8F – Relay B Off Delay

Range:	0:00 - 5:00 (minutes:seconds)	Default:	0 second
Description:	Sets the delay for re-opening Relay B.		

8G – Low Current Flag

The ASA 4.0 Basic has low and high current flags to give early warning of abnormal operation. The current flags can be configured to indicate an abnormal current level during operation, between the normal operating level and the undercurrent or instantaneous overcurrent trip levels. The flags can signal the situation to external equipment via one of the programmable outputs.

The flags clear when the current returns within the normal operating range by 10% of the programmed flag value.

Range: 1% - 100% FLC **Default:** 50%
Description: Sets the level at which the low current flag operates, as a percentage of motor full load current.

8H – High Current Flag

Range: 50% - 600% FLC **Default:** 100%
Description: Sets the level at which the high current flag operates, as a percentage of motor full load current.

8I – Motor Temperature Flag

The ASA 4.0 Basic has a motor temperature flag to give early warning of abnormal operation. The flag can indicate that the motor is operating above its normal operating temperature but lower than the overload limit. The flag can signal the situation to external equipment via one of the programmable outputs.

Range: 0% - 160% **Default:** 80%
Description: Sets the level at which the motor temperature flag operates, as a percentage of the motor's thermal capacity.

8J – Main Contactor Time

Range: 100 – 2000 milliseconds **Default:** 400 milliseconds
Description: Sets the delay period between the starter switching the main contactor output (terminals 33, 34) and beginning the pre-start checks (before a start) or entering the not ready state (after a stop). Set according to the specifications of the main contactor used.

9.11 9 Analog Output

9A – Analog Output A

Options: Current (% FLC) (default) Current as a percentage of motor full load current.
 Motor Temperature (%) The motor's temperature, calculated by the thermal model.
 Motor pf Motor power factor, measured by the soft starter.
 Heatsink Temperature (°C) The soft starter's temperature, measured at the heatsink.
Description: Selects which information will be reported via the analog output.

9B – Analog A Scale

Range: 0-20 mA
 4-20 mA (default)
Description: Selects the range of the analog output.

9C – Analog A Maximum Adjustment

Range: 0% - 600% **Default:** 100%
Description: Calibrates the upper limit of the analog output to match the signal measured on an external current measuring device.

9D – Analog A Minimum Adjustment

Range: 0% - 600% **Default:** 0%
Description: Calibrates the lower limit of the analog output to match the signal measured on an external current measuring device.

9.12 10 Display

10A – Language

Options: English (default) Português
 Chinese Français
 Español Italiano
 Deutsch Russian
Description: Selects which language the keypad will use to display messages and feedback.

10B – Temperature Scale

Options: Celsius (default)
Fahrenheit

Description: Selects whether the ASA 4.0 Basic will display temperatures in degrees Celsius or Fahrenheit.

10C – Graph Timebase

Options: 30 seconds (default)
1 minute
30 minutes
1 hour

Description: Sets the graph time scale. The graph will progressively replace the old data with new data.

10D – Graph Maximum Adjustment

Range: 0% – 600% **Default:** 400%

Description: Adjusts the upper limit of the performance graph.

10E – Graph Minimum Adjustment

Range: 0% – 600% **Default:** 0%

Description: Adjusts the lower limit of the performance graph.

10F – Current Calibration

Range: 85% - 115% **Default:** 100%

Description: Calibrates the soft starter's current monitoring circuits to match an external current metering device. Use the following formula to determine the necessary adjustment:

$$\text{Calibration (\%)} = \frac{\text{Current shown on ASA 4.0 Basic display}}{\text{Current measured by external device}}$$

10G – Adjustment Lock

Options: Read & Write (default) Allows users to alter parameter values in the main menu.
Read Only Prevents users altering parameter values in the main menu. Parameter values can still be viewed.

Description: Selects whether the keypad will allow parameters to be changed via the main menu.

10H – User Parameter 1

Options: Blank Displays no data in the selected area, allowing long messages to be shown without overlapping.

Current (default) Average rms current across all three phases

Mains Frequency The average frequency measured on three phases.

Motor pf The motor's power factor, measured by the soft starter.

Motor Temperature (%) The motor's temperature, calculated by the thermal model.

Hours Run The number of hours the motor has run via the soft starter.

Number of Starts The number of starts the ASA 4.0 Basic has completed since the start counter was last reset.

Pump Pressure The pressure at the pump, as configured in parameters 30B~30D. This information is only available if the smart card is installed.

Pump Flow The flow at the pump, as configured in parameters 30F~30K. This information is only available if the smart card is installed.

Well Depth The depth of the well, as configured in parameters 30M~30O. This information is only available if the smart card is installed.

Pump Temperature The pump temperature, as measured by the PT100. This information is only available if the smart card is installed.

Analog Output Value The value of the analog output (refer to parameters 9A~9D).

Heatsink Temperature The soft starter's temperature, measured at the heatsink.

Bypass Model (%) The percentage of thermal capacity remaining in the bypass contactor.

SCR Temperature The temperature of the SCRs, calculated by the thermal model.

Rating Capacity (%) The thermal capacity available in the soft starter for its next start.

Description: Selects which information will be displayed on the main monitoring screen.

10I – User Parameter 2

Options: Refer to parameter 10H *User Parameter 1* for details. **Default:** Mains Frequency
Description: Selects which information will be displayed on the main monitoring screen. Refer to parameter 10H *User Parameter 1* for details.

10J – User Parameter 3

Options: Refer to parameter 10H *User Parameter 1* for details. **Default:** Motor pf
Description: Selects which information will be displayed on the programmable monitoring screen. Refer to parameter 10H *User Parameter 1* for details.

10K – User Parameter 4

Options: Refer to parameter 10H *User Parameter 1* for details. **Default:** Motor Temperature (%)
Description: Selects which information will be displayed on the programmable monitoring screen. Refer to parameter 10H *User Parameter 1* for details.

10L – User Parameter 5

Options: Refer to parameter 10H *User Parameter 1* for details. **Default:** Hours Run
Description: Selects which information will be displayed on the programmable monitoring screen. Refer to parameter 10H *User Parameter 1* for details.

10M – User Parameter 6

Options: Refer to parameter 10H *User Parameter 1* for details. **Default:** Number of Starts
Description: Selects which information will be displayed on the programmable monitoring screen. Refer to parameter 10H *User Parameter 1* for details.

9.13

12 Communications Card

12A – Modbus Address

Range: 1 - 254 **Default:** 1
Description: Sets the Modbus RTU network address for the soft starter.

12B – Modbus Baud Rate

Options: 4800
 9600 (default)
 19200
 38400
Description: Selects the baud rate for Modbus RTU communications.

12C – Modbus Parity

Options: None (default)
 Odd
 Even
 10-bit
Description: Selects the parity for Modbus RTU communications.

12D – Modbus Timeout

Options: Off (default)
 10 seconds
 60 seconds
 100 seconds
Description: Selects the timeout for Modbus RTU communications.

12E – Devicenet Address

Range: 0 - 63 **Default:** 0
Description: Sets the DeviceNet network address for the soft starter.

12F – Devicenet Baud Rate

Options: 125 kB (default)
250 kB
500 kB

Description: Selects the baud rate for DeviceNet communications.

12G – Profibus Address

Range: 1 - 125 **Default:** 1

Description: Sets the Profibus network address for the soft starter.

12H – Gateway Address

Range: 0 - 255 **Default:** 192

Description: Sets the first component of the network gateway address. The gateway address is set using parameters 12H~12K and the default address is 192.168.0.100.

12I – Gateway Address 2

Range: 0 - 255 **Default:** 168

Description: Sets the second component of the network gateway address.

12J – Gateway Address 3

Range: 0 - 255 **Default:** 0

Description: Sets the third component of the network gateway address.

12K – Gateway Address 4

Range: 0 - 255 **Default:** 100

Description: Sets the fourth component of the network gateway address.



NOTE

The network address can also be set via the Network Address options in the Setup Tools. Refer to *Network Address* on page 26 for details.

12L – IP Address

Range: 0 - 255 **Default:** 192

Description: Sets the first component of the soft starter's IP address, for Ethernet communications. The IP address is set using parameters 12L~12O and the default address is 192.168.0.2.

12M – IP Address 2

Range: 0 - 255 **Default:** 168

Description: Sets the second component of the soft starter's IP address, for Ethernet communications.

12N – IP Address 3

Range: 0 - 255 **Default:** 0

Description: Sets the third component of the soft starter's IP address, for Ethernet communications.

12O – IP Address 4

Range: 0 - 255 **Default:** 2

Description: Sets the fourth component of the soft starter's IP address, for Ethernet communications.



NOTE

The network address can also be set via the Network Address options in the Setup Tools. Refer to *Network Address* on page 26 for details.

12P – Subnet Mask

Range: 0 - 255 **Default:** 255

Description: Sets the first component of the network subnet mask, for Ethernet communications. The subnet mask is set using parameters 12P~12S and the default mask is 255.255.255.0.

12Q – Subnet Mask 2

Range: 0 - 255 **Default:** 255
Description: Sets the second component of the network subnet mask, for Ethernet communications.

12R – Subnet Mask 3

Range: 0 - 255 **Default:** 255
Description: Sets the third component of the network subnet mask, for Ethernet communications.

12S – Subnet Mask 4

Range: 0 - 255 **Default:** 0
Description: Sets the fourth component of the network subnet mask, for Ethernet communications.



NOTE

The network address can also be set via the Network Address options in the Setup Tools. Refer to *Network Address* on page 26 for details.

12T – DHCP

Options: Disable (default)
 Enable
Description: Selects whether the communications card will accept an IP address assigned by DHCP.



NOTE

DHCP addressing is available with Modbus TCP and Ethernet/IP. DHCP addressing is not supported with Profinet.

12U – Location ID

Range: 0 - 65535 **Default:** 0
Description: Sets the soft starter's unique location ID.

9.14

20 Advanced

20A – Tracking Gain

Range: 1% - 200% **Default:** 50%
Description: Fine-tunes the behaviour of the adaptive control algorithm.

20B – Pedestal Detect

Range: 0% - 200% **Default:** 80%
Description: Adjusts the behaviour of the adaptive control algorithm for soft stop.

20C – Bypass Contactor Delay

Range: 100 – 2000 milliseconds **Default:** 150 milliseconds
Description: Sets the starter to match the bypass contactor closing/opening time. Set according to the specifications of the bypass contactor used. If this time is too short, the starter will trip.

20D – Model Rating

Range: 0020–0580 **Default:** Model dependent

Description: The soft starter's internal model reference, as shown on the silver label on the side of the unit (**1**).

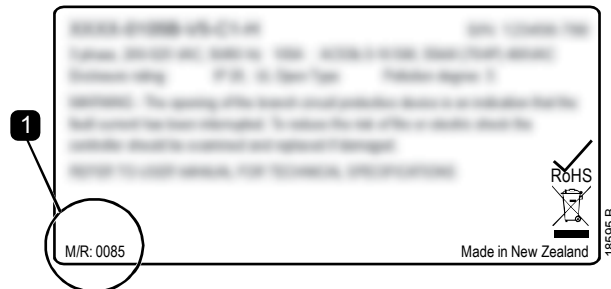

NOTE

This parameter can only be adjusted by authorised servicing agents.

20E – Screen Timeout

Options: 1 minute (default) 4 minutes
2 minutes 5 minutes
3 minutes

Description: Sets the timeout for the menu to automatically close if no keypad activity is detected.

20F – Motor Connection

Options: Auto-detect (default)
In-line

Description: Override the soft starter's motor connection checks, where the connection is not correctly recognised on a grounded delta supply.

9.15 30 Pump Input Configuration



NOTE

The parameters in this group are only active if a smart card is installed.

30A – Pressure Sensor Type

Options: None (default)
Switch
Analog

Description: Selects which type of sensor is associated with the pressure sensor input on the smart card.

30B – Pressure Units

Options: Bar
kPa (default)
Psi

Description: Selects which units the sensor will use to report the measured pressure.

30C – Pressure at 4 mA

Range: 0 – 5000 **Default:** 0

Description: Calibrates the soft starter to the 4 mA (0%) level of the pressure sensor input.

30D – Pressure at 20 mA

Range: 0 – 5000 **Default:** 0

Description: Calibrates the soft starter to the 20 mA (100%) level of the pressure sensor input.

30E – Flow Sensor Type

Options: None (default) Pulses per minute
Switch Pulses per unit
Analog

Description: Selects which type of sensor is associated with the flow sensor input on the smart card.

30F – Flow Units

Options: litres/second (default)
litres/minute
gallons/second
gallons/minute

Description: Selects which units the sensor will use to report the measured flow.

30G – Flow at 4 mA

Range: 0 – 5000 **Default:** 0

Description: Calibrates the soft starter to the 4 mA (0%) level of the flow sensor input.

30H – Flow at 20 mA

Range: 0 – 5000 **Default:** 0

Description: Calibrates the soft starter to the 20 mA (100%) level of the flow sensor input.

30I – Units per Minute at Max Flow

Range: 0 – 5000 **Default:** 0

Description: Calibrates the soft starter to the maximum flow volume of the flow sensor.

30J – Pulses per Minute at Max Flow

Range: 0 – 20000 **Default:** 0

Description: Calibrates the soft starter to the maximum flow volume of the flow sensor.

30K – Units per Pulse

Range: 0 – 1000 **Default:** 0

Description: Set to match how many units the flow sensor will measure for each pulse.

30L – Depth Sensor Type

Options: None (default)
Switch
Analog

Description: Selects which type of sensor is associated with the depth sensor input on the smart card.

30M – Depth Units

Options: metres (default)
feet

Description: Selects which units the sensor will use to report the measured depth.

30N – Depth at 4 mA

Range: 0 – 1000 **Default:** 0

Description: Calibrates the soft starter to the 4 mA (0%) level of the depth sensor input.

30O – Depth at 20 mA

Range: 0 – 1000 **Default:** 0

Description: Calibrates the soft starter to the 20 mA (100%) level of the depth sensor input.

9.16 31 Flow Protection



NOTE
The parameters in this group are only active if a smart card is installed.

Flow protection uses terminals B33, B34 or C23, C24 on the smart card.

31A – High Flow Trip Level

Range: 0 – 5000 **Default:** 10
Description: Sets the trip point for high flow protection.

31B – Low Flow Trip Level

Range: 1 – 5000 **Default:** 5
Description: Sets the trip point for low flow protection.

31C – Flow Start Delay

Range: 00:00:50 - 30:00:00 mm:ss:ms **Default:** 00:00:500 ms
Description: Sets a delay before a flow protection trip can occur. The delay is counted from the time a start signal is received. The flow level is ignored until the start delay has elapsed.

31D – Flow Response Delay

Range: 00:00:10 - 30:00:00 mm:ss:ms **Default:** 00:00:500 ms
Description: Sets a delay between the flow passing the high or low flow trip levels, and the soft starter tripping.

9.17 32 Pressure Protection



NOTE
The parameters in this group are only active if a smart card is installed.

Pressure protection uses terminals B23, B24 or C33, C34, C43, C44 on the smart card.

32A – High Pressure Trip Level

Range: 0 – 5000 **Default:** 10
Description: Sets the trip point for high pressure protection.

32B – High Pressure Start Delay

Range: 00:00:10 – 30:00:00 mm:ss:ms **Default:** 00:00:500 ms
Description: Sets a delay before a high pressure protection trip can occur. The delay is counted from the time a start signal is received. The pressure is ignored until the start delay has elapsed.

32C – High Pressure Response Delay

Range: 00:00:10 – 30:00:00 mm:ss:ms **Default:** 00:00:500 ms
Description: Sets a delay between the pressure passing the high pressure trip level, and the soft starter tripping.

32D – Low Pressure Trip Level

Range: 0 – 5000 **Default:** 5
Description: Sets the trip point for low pressure protection.

32E – Low Pressure Start Delay

Range: 00:00:10 – 30:00:00 mm:ss:ms **Default:** 00:00:500 ms
Description: Sets a delay before a low pressure protection trip can occur. The delay is counted from the time a start signal is received. The pressure is ignored until the start delay has elapsed.

32F – Low Pressure Response Delay

Range: 00:00:10 – 30:00:00 mm:ss:ms **Default:** 00:00:500 ms
Description: Sets a delay between the pressure passing the low pressure trip level, and the soft starter tripping.

9.18 33 Pressure Control



NOTE
The parameters in this group are only active if a smart card is installed.

Pressure control uses terminals B23, B24 on the smart card. Use an analog 4-20 mA sensor.

33A – Pressure Control Mode

Options:	Off (default)	The soft starter will not use the pressure sensor to control soft starting.
	Falling Pressure Start	The soft starter will start when the pressure drops below the level selected in parameter 33B <i>Start Pressure Level</i> .
	Rising Pressure Start	The soft starter will start when the pressure rises above the level selected in parameter 33B <i>Start Pressure Level</i> .
Description:	Selects how the soft starter will use data from the pressure sensor to control the motor.	

33B – Start Pressure Level

Range:	1 – 5000	Default:	5
Description:	Sets the pressure level to trigger the soft starter to perform a soft start.		

33C – Start Response Delay

Range:	00:00:10 – 30:00:00 mm:ss:ms	Default:	00:00:500 ms
Description:	Sets a delay between the pressure passing the pressure control start level, and the soft starter performing a soft start.		

33D – Stop Pressure Level

Range:	0 – 5000	Default:	10
Description:	Sets the pressure level to trigger the soft starter to stop the motor.		

33E – Stop Response Delay

Range:	00:00:10 – 30:00:00 mm:ss:ms	Default:	00:00:500 ms
Description:	Sets a delay between the pressure passing the pressure control stop level, and the soft starter stopping the motor.		

9.19 34 Depth Protection



NOTE
The parameters in this group are only active if a smart card is installed.

Depth protection uses terminals B13, B14 or C13, C14 on the smart card.

34A – Depth Trip Level

Range:	0 – 1000	Default:	5
Description:	Sets the trip point for depth protection.		

34B – Depth Reset Level

Range:	0 – 1000	Default:	10
Description:	Sets the level for the soft starter to auto-reset a depth trip.		

34C – Depth Start Delay

Range:	00:00:10 – 30:00:00 mm:ss:ms	Default:	00:00:500 milliseconds
Description:	Sets a delay before a depth protection trip can occur. The delay is counted from the time a start signal is received. The depth input is ignored until the start delay has elapsed.		

34D – Depth Response Delay

Range:	00:00:10 – 30:00:00 mm:ss:ms	Default:	00:00:500 ms
Description:	Sets a delay between the depth passing the depth protection trip level, and the soft starter tripping.		

9.20 35 Thermal Protection



NOTE

The parameters in this group are only active if a smart card is installed.

35A – Temperature Sensor Type

Options: None (default)
PT100

Description: Selects which type of sensor is associated with the temperature sensor input on the smart card.

35B – Temperature Trip Level

Range: 0° – 240° **Default:** 40°

Description: Sets the trip point for temperature protection. Use parameter 10B *Temperature Scale* to configure the temperature scale.

9.21 36 Pump Trip Action

36A – Pressure Sensor

Options: Soft Trip and Log (default) Trip and Reset
Soft Trip and Reset Warn and Log
Trip Starter Log Only

Description: Selects the soft starter's response if it detects a fault with the pressure sensor.

36B – Flow Sensor

Options: Soft Trip and Log (default) Trip and Reset
Soft Trip and Reset Warn and Log
Trip Starter Log Only

Description: Selects the soft starter's response if it detects a fault with the flow sensor.

36C – Depth Sensor

Options: Soft Trip and Log (default) Trip and Reset
Soft Trip and Reset Warn and Log
Trip Starter Log Only

Description: Selects the soft starter's response if it detects a fault with the depth sensor.

36D – High Pressure

Options: Soft Trip and Log (default) Trip and Reset
Soft Trip and Reset Warn and Log
Trip Starter Log Only

Description: Selects the soft starter's response if the pressure exceeds the high pressure trip level (parameter 32A) or the high pressure switch sensor closes.

36E – Low Pressure

Options: Soft Trip and Log (default) Trip and Reset
Soft Trip and Reset Warn and Log
Trip Starter Log Only

Description: Selects the soft starter's response if the pressure falls below the low pressure trip level (parameter 32D) or the low pressure switch sensor closes.

36F – High Flow

Options: Soft Trip and Log (default) Trip and Reset
Soft Trip and Reset Warn and Log
Trip Starter Log Only

Description: Selects the soft starter's response if the flow exceeds the high flow trip level (parameter 31A).

36G – Low Flow

Options:	Soft Trip and Log (default)	Trip and Reset
	Soft Trip and Reset	Warn and Log
	Trip Starter	Log Only

Description: Selects the soft starter's response if the flow falls below the low flow trip level (parameter 31B).

36H – Flow Switch

Options:	Soft Trip and Log (default)	Trip and Reset
	Soft Trip and Reset	Warn and Log
	Trip Starter	Log Only

Description: Selects the soft starter's response if the flow sensor closes (switch type sensors only).

36I – Well Depth

Options:	Soft Trip and Log (default)	Trip and Reset
	Soft Trip and Reset	Warn and Log
	Trip Starter	Log Only

Description: Selects the soft starter's response if the depth falls below the depth trip level (parameter 34A) or the depth switch sensor closes.

36J – RTD/PT100 B

Options:	Soft Trip and Log (default)	Trip and Reset
	Soft Trip and Reset	Warn and Log
	Trip Starter	Log Only

Description: Selects the soft starter's response to the protection event.

10 Application Examples

10.1 Smart Card - Pump Protection

The ASA 4.0 Basic smart card is ideal for applications with extensive external inputs, such as pumping situations where external sensors provide additional protection to the pump and motor.

In this example, the soft starter controls a bore pump. The pump is manually started and stopped using the digital control inputs. Three 4-20 mA transducers are used to monitor water depth, pipe pressure and flow.

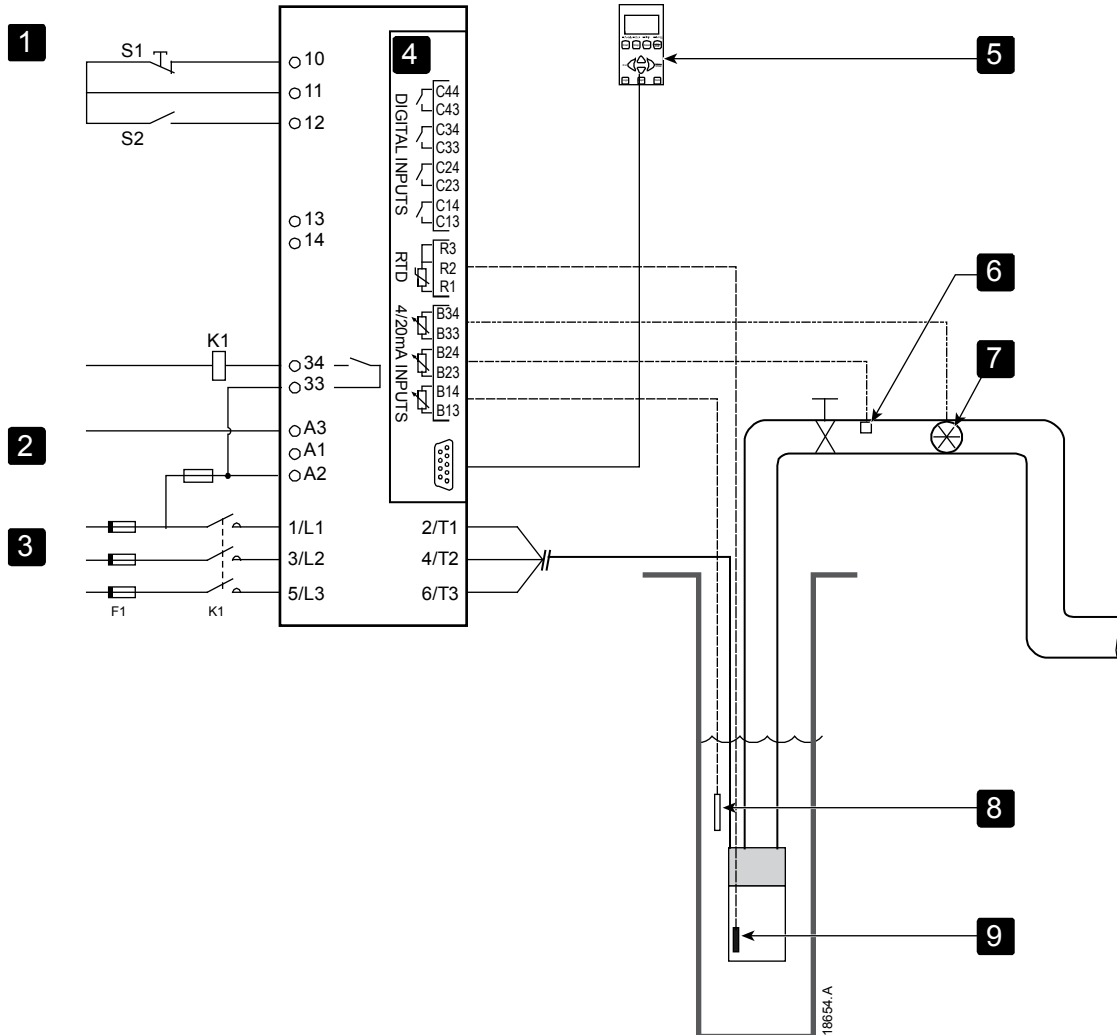

1	Digital inputs
2	Control voltage
3	Three-phase supply
4	Smart card
5	Remote keypad (optional)
6	Pressure sensor
7	Flow sensor
8	Depth sensor
9	Temperature sensor

10, 11	Reset input (S1)
11, 12	Start/stop input (S2)
33, 34	Main contactor output
R1, R2, R3	Motor temperature protection
B33, B34	Flow protection
B23, B24	Pressure protection
B13, B14	Depth protection
K1	Main contactor

Parameter settings:

- Parameter 1A *Command Source*: select 'Digital Input'.
- Parameters 30A~30O Pump Input Configuration: Set as required.
- Parameters 31A~31D Flow Protection: Set as required.
- Parameters 32A~32F Pressure Protection: Set as required.
- Parameters 34A~34D Depth Protection: Set as required.
- Parameters 35A~35B Thermal Protection: Set as required.

10.2 Smart Card - Level Controlled Pump Activation

The ASA 4.0 Basic smart card can be used to control start/stop activation of the starter, based on information from external inputs.

In this example, the ASA 4.0 Basic controls a pump which fills a tank, with maximum and minimum water levels. A pressure sensor is used to monitor the level of water in the tank and trigger the pump to fill the tank when water drops below the minimum level, and shut off the pump when the maximum water level is reached.

A three-way selector switch allows the user to override sensor-based control, and manually start or stop the motor.

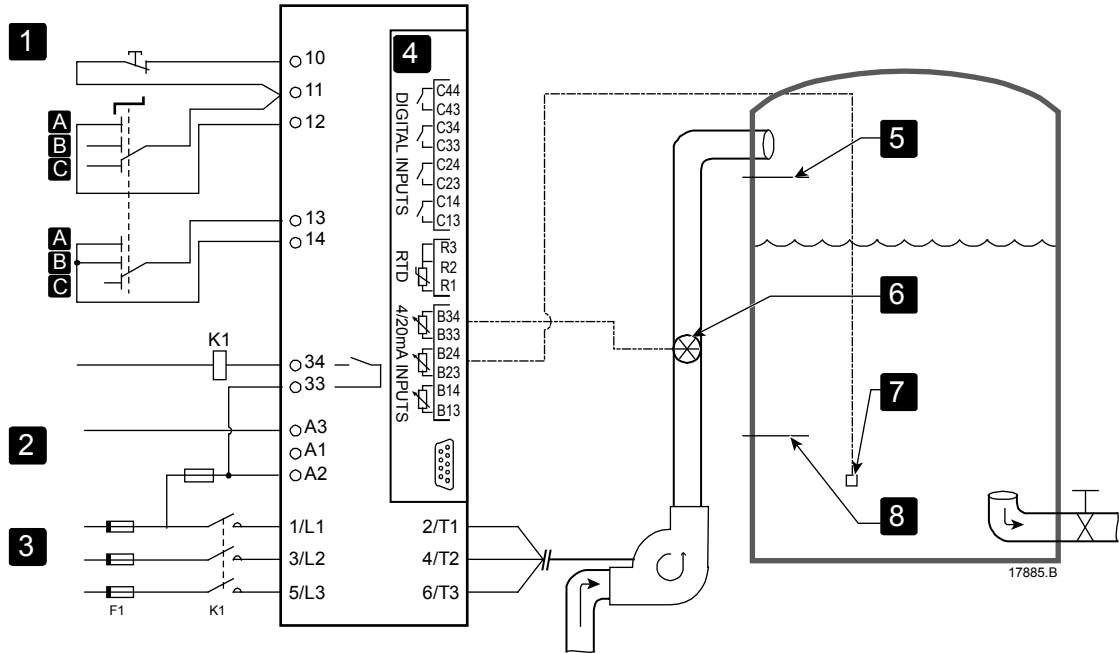

1	Digital inputs
A	Manual start
B	Manual stop
C	Automatic operation (level-controlled)
2	Control voltage
3	Three-phase supply
4	Smart card
5	Maximum water level
6	Flow sensor
7	Pressure sensor
8	Minimum water level

K1	Main contactor
10, 11	Reset input
11, 12	Start/stop input
13, 14	Programmable input A (set = Command Override: Digital)
33, 34	Main contactor output
B33, B34	Flow protection
B23, B24	Pressure or depth based control

Parameter settings:

- Parameter 1A *Command Source*: select 'Smart Card'.
- Parameter 7A *Input A Function*: select 'Command Override: Digital'.
- Parameters 30A~30O *Pump Input Configuration*: Set as required.
- Parameters 31A~31D *Flow Protection*: Set as required.
- Parameters 33A~33E *Pressure Control*: Set as required.

11 Troubleshooting

11.1 Protection Responses

When a protection condition is detected, the ASA 4.0 Basic will write this to the event log and may also trip or issue a warning. The soft starter's response depends on the Protection Action setting (parameter group 6).

Some protection responses cannot be adjusted by the user. These trips are usually caused by external events (such as phase loss) or by a fault within the soft starter. These trips do not have associated parameters and cannot be set to Warn or Log.

If the ASA 4.0 Basic trips you will need to identify and clear the condition that triggered the trip, then reset the soft starter before restarting. To reset the starter, press the **RESET** button on the keypad or activate the Reset remote input.

If the ASA 4.0 Basic has issued a warning, the soft starter will reset itself once the cause of the warning has been resolved.

11.2 Trip Messages

Display	Possible cause/Suggested solution
BYPASS OVERLOAD	This trip is not adjustable. Bypass overload protection protects the soft starter from severe operating overloads while running. The soft starter will trip if it detects overcurrent at 600% of the contactor rating. Related parameters: None
CURRENT IMBALANCE	Current imbalance can be caused by problems with the motor, the environment or the installation, such as: <ul style="list-style-type: none"> An imbalance in the incoming mains voltage A problem with the motor windings A light load on the motor A phase loss on input terminals L1, L2 or L3 during Run mode An SCR that has failed open circuit. A failed SCR can only be definitely diagnosed by replacing the SCR and checking the starter's performance. Related parameters: 5A, 5B, 6C
CURRENT READ ERR LX	Where 'X' is 1, 2 or 3. Internal fault (PCB fault). The output from the CT circuit is not close enough to zero when the SCRs are turned off. Contact your local supplier for advice. Related parameters: None
DEPTH SENSOR	The smart card has detected a fault with the depth sensor. Related parameters: 30L, 36C
EEPROM FAIL	An error occurred loading data from the EEPROM to RAM when the keypad powered up. If the problem persists, contact your local distributor. Related parameters: None
EXCESS START TIME	Excess start time trip can occur in the following conditions: <ul style="list-style-type: none"> parameter 1B <i>Motor Full Load Current</i> is not appropriate for the motor parameter 2D <i>Current Limit</i> has been set too low parameter 2B <i>Start Ramp Time</i> has been set greater than the setting for 5G <i>Excess Start Time</i> parameter 2B <i>Start Ramp Time</i> is set too short for a high inertia load when using Adaptive Control Related parameters: 1B, 2B, 2D, 3D, 3F
FIRING FAIL PX	Where 'X' is phase 1, 2 or 3. The SCR did not fire as expected. The SCR may be faulty or there may be an internal wiring fault. Related parameters: None
FLOW SENSOR	The smart card has detected a fault with the flow sensor. Related parameters: 30E, 36B
FLOW SWITCH	The flow switch sensor (smart card terminals C23, C24) has closed. Related parameters: 30E, 36H
FREQUENCY	This trip is not adjustable. The mains frequency has gone beyond the specified range. Check for other equipment in the area that could be affecting the mains supply, particularly variable speed drives and switch mode power supplies (SMPS). If the ASA 4.0 Basic is connected to a generator set supply, the generator may be too small or could have a speed regulation problem. Related parameters: 6K
HEATSINK OVERTEMPERATURE	<ul style="list-style-type: none"> Check that bypass contactors are operating. Check that cooling fans are operating (models ASA4.0-B 0064B~ASA4.0-B 0580B). If mounted in an enclosure, check if ventilation is adequate. The ASA 4.0 Basic must be mounted vertically. Related parameters: None
HIGH FLOW	The flow sensor connected to the smart card has activated high flow protection. Related parameters: 30E, 30G, 30H, 31A, 31C, 31D, 36F

Display	Possible cause/Suggested solution
HIGH PRESSURE	The pressure sensor connected to the smart card has activated high pressure protection. Related parameters: 30A, 30C, 30D, 32A, 32B, 32C, 36D
INPUT A TRIP INPUT B TRIP	The soft starter's programmable input is set to a trip function and has activated. Resolve the trigger condition. Related parameters: 7A, 7B, 7C, 7D, 7E, 7F, 7G, 7H
INSTANTANEOUS OVERCURRENT	This trip is not adjustable. The current on all three phases has exceeded 7.2 times the value of parameter 1B <i>Motor Full Load Current</i> . Causes can include a locked rotor condition or an electrical fault in the motor or cabling. Related parameters: None
INTERNAL FAULT X	Where 'X' is a number. This trip is not adjustable. The ASA 4.0 Basic has tripped on an internal fault. Contact your local supplier with the fault code (X).
INTERNAL FAULT 88	The soft starter firmware does not match the hardware.
KEYPAD DISCONNECTED	Parameter 1A <i>Command Source</i> is set to Remote Keypad but the ASA 4.0 Basic cannot detect a remote keypad. If a remote keypad is installed, check the cable is firmly connected to the soft starter. If no remote keypad is installed, change the setting of parameter 1A. Related parameters: 1A
L1 PHASE LOSS L2 PHASE LOSS L3 PHASE LOSS	This trip is not adjustable. During pre-start checks the starter has detected a phase loss as indicated. In run state, the starter has detected that the current on the affected phase has dropped below 10% of the programmed motor FLC for more than 1 second, indicating that either the incoming phase or connection to the motor has been lost. Check the supply and the input and output connections at the starter and at the motor end. Related parameters: None
L1-T1 SHORTED L2-T2 SHORTED L3-T3 SHORTED	During pre-start checks the starter has detected a shorted SCR or a short within the bypass contactor as indicated. Related parameters: 6S
LOW CONTROL VOLTS	The ASA 4.0 Basic has detected a drop in the internal control voltage. <ul style="list-style-type: none"> Check the external control supply (A1, A2, A3) and reset the starter. If the external control supply is stable: <ul style="list-style-type: none"> the 24 V supply on the main control PCB may be faulty; or the bypass driver PCB may be faulty. Contact your local supplier for advice. This protection is not active in Ready state. Related parameters: None
LOW FLOW	The flow sensor connected to the smart card has activated low flow protection. Related parameters: 30E, 30G, 30H, 31B, 31C, 31D, 36G
LOW PRESSURE	The pressure sensor connected to the smart card has activated low pressure protection. Related parameters: 30A, 30C, 30D, 32D, 32E, 32F, 36E
LOW WATER	The depth sensor connected to the smart card has activated depth protection. Related parameters: 30L, 30N, 30O, 34A, 34B, 34C, 36I
MOTOR CONNECTION	This trip is not adjustable. <ul style="list-style-type: none"> Ensure the motor is connected to terminals T1, T2, T3 using in-line (three wire) connection. The ASA 4.0 Basic does not support inside delta (six wire) connection. If the soft starter is connected to a grounded delta mains supply, the starter may incorrectly detect the motor configuration. Set parameter 20F <i>Motor Connection</i> to 'In-line'. Related parameters: 20F
MOTOR CONNECTION T1 MOTOR CONNECTION T2 MOTOR CONNECTION T3	This trip is not adjustable. The motor is not connected correctly to the soft starter. <ul style="list-style-type: none"> Check individual motor connections to the soft starter for power circuit continuity. Check connections at the motor terminal box. Related parameters: None

Display	Possible cause/Suggested solution
MOTOR OVERLOAD	<p>The motor has reached its maximum thermal capacity. Overload can be caused by:</p> <ul style="list-style-type: none"> • The soft starter protection settings not matching the motor thermal capacity • Excessive starts per hour or start duration • Excessive current • Damage to the motor windings <p>Resolve the cause of the overload and allow the motor to cool. Related parameters: 1B, 1C, 1D, 1E, 5G, 6F</p> <p> NOTE Parameters 1C, 1D and 1E determine the trip current for motor overload protection. The default settings of parameters 1C, 1D and 1E provide Motor Overload Protection: Class 10, Trip Current 105% of FLA (full load amperage) or equivalent.</p>
MOTOR THERMISTOR	<p>The motor thermistor input has been enabled and:</p> <ul style="list-style-type: none"> • The resistance at the thermistor input has exceeded 3.6 kΩ for more than one second. • The motor winding has overheated. Identify the cause of the overheating and allow the motor to cool before restarting. • The motor thermistor input has been opened. <p>If thermistors have previously been connected to the ASA 4.0 Basic but are no longer required, use the Thermistor Reset function to disable the thermistor. Related parameters: 6M</p>
NETWORK COMMUNICATION	<p>There is a network communication problem, or the network master may have sent a trip command to the starter. Check the network for causes of communication inactivity. Related parameters: 6I</p>
NOT READY	<ul style="list-style-type: none"> • The reset input may be active. If the reset input is active, the starter will not operate. • The soft starter may be waiting for the restart delay to elapse. The length of the restart delay is controlled by parameter 5H <i>Restart Delay</i>. <p>Related parameters: 5H</p>
OVERCURRENT	<p>The current has exceeded the level set in parameter 5E <i>Overcurrent</i> for longer than the time set in parameter 5F <i>Overcurrent Delay</i>. Causes can include a momentary overload condition. Related parameters: 5E, 5F, 6E</p>
PARAMETER OUT OF RANGE	<p>This trip is not adjustable.</p> <ul style="list-style-type: none"> • A parameter value is outside the valid range. The keypad will indicate the first invalid parameter. • An error occurred loading data from the EEPROM to RAM when the keypad powered up. • The parameter set or values in the keypad do not match the parameters in the starter. • "Load User Set" has been selected but no saved file is available. <p>Reset the fault. The starter will load the default settings. If the problem persists, contact your local distributor. Related parameters: None</p>
PHASE SEQUENCE	<p>The phase sequence on the soft starter's input terminals (L1, L2, L3) is not valid. Check the phase sequence on L1, L2, L3 and ensure the setting in parameter 5J is suitable for the installation. Related parameters: 5J, 6L</p>
POWER LOSS	<p>This trip is not adjustable. The starter is not receiving mains supply on one or more phases. Check that the main contactor closes when a start command is given, and remains closed until the end of a soft stop. Check the fuses. If testing the soft starter with a small motor, it must draw at least 10% of the starter's programmed FLC setting on each phase. Related parameters: None</p>
PRESSURE SENSOR	<p>The smart card has detected a fault with the pressure sensor. Related parameters: 30A, 36A</p>
RATING CAPACITY	<p>The ASA 4.0 Basic is operating beyond its safe capacity. Allow the starter to cool. Related parameters: None</p>
RTD CIRCUIT	<p>The smart card has detected a fault with the RTD sensor, or the RTD has activated temperature protection. Related parameters: 35B, 36J</p>
SCR ITSM	<p>The SCR current surge rating has been exceeded. Related parameters: None</p>
SCR OVERTEMPERATURE	<p>The temperature of the SCRs, calculated by the thermal model, is too high to allow further operation. Wait for the starter to cool. Related parameters: None</p>
STARTER COMMUNICATION	<p>There is a problem with the connection between the soft starter and the optional expansion card. Remove and reinstall the card. If the problem persists, contact your local distributor. Related parameters: None</p>

Display	Possible cause/Suggested solution
STARTS PER HOUR	The soft starter has already attempted the maximum number of starts in the last 60 minutes. Wait before attempting another start. To determine when the waiting period will end, review the log. Related parameters: 5I
THERMISTOR CIRCUIT	The thermistor input has been enabled and: <ul style="list-style-type: none"> The resistance at the input has fallen below 20 Ω (the cold resistance of most thermistors will be over this value) or A short circuit has occurred. Check and resolve this condition. Related parameters: None
TIME-OVERCURRENT	The ASA 4.0 Basic is internally bypassed and has drawn high current during running. (The 10A protection curve trip has been reached or the motor current has risen to 600% of the motor FLC setting.) Related parameters: None
UNDERCURRENT	The motor has experienced a sharp drop in current, caused by loss of load. Causes can include broken components (shafts, belts or couplings), or a pump running dry. Related parameters: 5C, 5D, 6D
U2C FAIL PX	Where 'X' is 1, 2 or 3. Internal fault (PCB fault). Contact your local supplier for advice. Related parameters: None

11.3 General Faults

This table describes situations where the soft starter does not operate as expected but does not trip or give a warning.

Symptom	Probable Cause
Starter "Not Ready"	<ul style="list-style-type: none"> The reset input may be active. If the reset input is active, the starter will not operate.
"Simul" on display	<ul style="list-style-type: none"> The starter is running simulation software. This software is intended for demonstration purposes only and is not suitable for controlling a motor. Contact your local supplier for advice.
The soft starter does not respond to the START or RESET button on the keypad.	<ul style="list-style-type: none"> The soft starter will only accept commands from the keypad if parameter 1A <i>Command Source</i> is set to Remote Keypad. Check that the Local LED on the starter is on.
The soft starter does not respond to commands from the control inputs.	<ul style="list-style-type: none"> The soft starter will only accept commands from the inputs if parameter 1A <i>Command Source</i> is set to Digital Input. Check the setting of 1A. The control wiring may be incorrect. Check that the remote start, stop and reset inputs are configured correctly (refer to <i>Start/Stop</i> on page 18 for details). The signals to the remote inputs may be incorrect. Test the signalling by activating each input signal in turn.
The soft starter does not respond to a start command from either the keypad or the digital inputs.	<ul style="list-style-type: none"> The soft starter may be waiting for the restart delay to elapse. The length of the restart delay is controlled by parameter 5H <i>Restart Delay</i>. The motor may be too hot to permit a start. The soft starter will only permit a start when it calculates that the motor has sufficient thermal capacity to complete the start successfully. Wait for the motor to cool before attempting another start. The reset input may be active. If the reset input is active, the starter will not operate. The soft starter may be waiting for control signals via the communications network (parameter 1A <i>Command Source</i> = Network).
Remote keypad shows message "awaiting data"	The keypad is not receiving data from the control PCB. Check the cable connection.
The soft starter does not control the motor correctly during starting.	<ul style="list-style-type: none"> Start performance may be unstable when using a low <i>Motor Full Load Current</i> setting (parameter 1B). Power factor correction (PFC) capacitors must be installed on the supply side of the soft starter and must be disconnected during starting and stopping. To use the ASA 4.0 Basic to control power factor correction, connect the PFC contactor to a programmable relay set to Run. High levels of harmonics on the mains supply can affect soft starter performance. If variable speed drives are installed nearby, check they are properly grounded and filtered.
Motor does not reach full speed.	<ul style="list-style-type: none"> If the start current is too low, the motor will not produce enough torque to accelerate to full speed. The soft starter may trip on excess start time. <p>NOTE</p>  <p>Make sure the motor starting parameters are appropriate for the application and that you are using the intended motor starting profile. If a programmable input is set to Motor Set Select, check that the corresponding input is in the expected state.</p> <ul style="list-style-type: none"> The load may be jammed. Check the load for severe overloading or a locked rotor situation.

Symptom	Probable Cause
Soft stop ends too quickly.	<ul style="list-style-type: none"> The soft stop settings may not be appropriate for the motor and load. Review the soft stop settings. If the motor is very lightly loaded, soft stop will have limited effect.
After selecting Adaptive Control the motor used an ordinary start and/or the second start was different to the first.	<ul style="list-style-type: none"> The first Adaptive Control start is actually 'Constant Current' so that the starter can learn from the motor characteristics. Subsequent starts use Adaptive Control.
Parameter settings cannot be stored.	<ul style="list-style-type: none"> Make sure you are saving the new value by pressing the STORE button after adjusting a parameter setting. If you press EXIT, the change will not be saved. The ASA 4.0 Basic does not display a confirmation. Check that the adjustment lock (parameter 10G) is set to Read & Write. If the adjustment lock is set to Read Only, settings can be viewed but not changed.
USB Full	<ul style="list-style-type: none"> The USB drive may not have enough free space available for the selected function. The file system on the USB drive may not be compatible with the soft starter. The ASA 4.0 Basic supports FAT32 file systems. The ASA 4.0 Basic's USB functions are not compatible with NTFS file systems.
USB Missing	A USB function has been selected in the menu, but the product cannot detect a USB drive. Check that the USB drive has been inserted in the port.
File Missing	A USB function has been selected in the menu, but the required file cannot be found. Save/Load Master Parameters uses a file called Master_Parameters.par, at the top level of the USB drive. For these functions to work correctly, do not move or rename this file.
File Not Valid	A USB function has been selected in the menu, but the file is not valid.
File Empty	A USB function has been selected in the menu and the file has been found, but does not contain the expected content.
Rating Not Valid	The value of parameter 20D <i>Model Rating</i> is incorrect. Parameter 20D is not user-adjustable. Contact your local supplier for advice.

